



---

**COMMUNITY GUIDE to GOOD PRACTICE  
for Hygiene and the application of the  
HACCP principles in the production of  
natural sausage casings**

---

## **PREFACE**

In accordance with article 9 of Regulation (EC) No 853/2004 of the European Parliament and of the Council on the hygiene of foodstuffs, the European Natural Sausage Casings Association (ENSCA) welcomes the opportunity to issue this voluntary Community Guide to Good Practice for hygiene and the application of the HACCP principles in the production of natural sausage casings.

This document is mainly intended for the European natural sausage casing industry and its aim is to assist in the implementation of the European Hygiene Package and HACCP principles according to the Codex Alimentarius.

Version VIII, June 2019 / revised Chapter 2, Annexes I, IV & V

Edited by Dr. Joris J. Wijnker, Specialist RNVA Veterinary Public Health

Copyright © European Natural Sausage Casings Association ENSCA 2019  
All rights reserved

# INDEX

|   |    |
|---|----|
| INTRODUCTION .....  | 5  |
| 1.1 Purpose.....  | 5  |
| 1.2 Scope.....  | 5  |
| 2. THE PRODUCTION OF NATURAL SAUSAGE CASINGS .....        | 7  |
| 2.1 Definition of natural (sausage) casings.....          | 7  |
| 2.2 Description of natural casings .....                  | 10 |
| 2.3 Processing of natural casings.....                    | 12 |
| 2.3.1 Cleaning operations.....                            | 12 |
| 2.3.2 Sorting operations .....                            | 14 |
| 2.3.3 Distribution (repacking) centres .....              | 14 |
| 3. PREREQUISITE REQUIREMENTS .....                        | 15 |
| 3.1 Primary production .....                              | 15 |
| 3.2 Establishment: design and facilities.....             | 15 |
| 3.2.1 Location.....                                       | 15 |
| 3.2.2 Premises and rooms .....                            | 15 |
| 3.2.3 Equipment .....                                     | 16 |
| 3.2.4 Facilities .....                                    | 16 |
| 3.3 Control of operation .....                            | 17 |
| 3.3.1 Control of food hazards .....                       | 17 |
| 3.3.2 Key aspects of hygiene control systems .....        | 17 |
| 3.3.3 Incoming material requirements.....                 | 17 |
| 3.3.4 Packaging .....                                     | 17 |
| 3.3.5 Water .....   | 17 |
| 3.3.6 Management and supervision.....                     | 18 |
| 3.3.7 Documentation and records .....                     | 18 |
| 3.3.8 Product traceability procedures .....               | 18 |
| 3.4 Establishment: maintenance and sanitation .....       | 18 |
| 3.4.1 Maintenance and cleaning.....                       | 18 |
| 3.4.2 Cleaning programme .....                            | 18 |
| 3.4.3 Pest control systems.....                           | 19 |
| 3.4.4 Waste management .....                              | 19 |
| 3.4.5 Monitoring effectiveness .....                      | 19 |
| 3.5 Establishment: personal hygiene.....                  | 19 |
| 3.5.1 Health status .....                                 | 19 |
| 3.5.2 Personal cleanliness and behaviour .....            | 20 |
| 3.6 Transportation .....                                  | 20 |
| 3.7 Product information .....                             | 20 |
| 3.8 Training .....  | 20 |
| 4. HACCP PLAN FOR THE PRODUCTION OF NATURAL CASINGS ..... | 22 |
| 4.1 Hazard Identification.....                            | 22 |
| 4.1.1 Biological hazards.....                             | 22 |
| 4.1.2 Chemical hazards .....                              | 23 |
| 4.1.3 Physical hazards.....                               | 25 |
| 4.2 Hazard Analysis .....                                 | 25 |

|       |   |    |
|-------|---|----|
| 4.2.1 | Biological hazards.....                                     | 26 |
| 4.2.2 | Physical hazards.....                                       | 27 |
| 4.3   | Prerequisite Control Measures.....                          | 28 |
| 4.4   | CCP 1 Removal of SRM.....                                   | 30 |
| 4.4.1 | Identification of critical control point 1.....             | 30 |
| 4.4.2 | Critical limits at critical control point .....             | 30 |
| 4.4.3 | Monitoring procedures at critical control point.....        | 30 |
| 4.4.4 | Corrective actions.....                                     | 31 |
| 4.4.5 | Verification procedures .....                               | 31 |
| 4.4.6 | Documentation and record keeping .....                      | 31 |
| 4.5   | CCP 2 Salting.....  | 31 |
| 4.5.1 | Identification of critical control point 2.....             | 31 |
| 4.5.2 | Critical limits at critical control point .....             | 32 |
| 4.5.3 | Monitoring procedures at critical control point.....        | 32 |
| 4.5.4 | Corrective actions.....                                     | 32 |
| 4.5.5 | Verification procedures .....                               | 32 |
| 4.5.6 | Documentation and record keeping .....                      | 33 |
| 4.6   | CCP 3 Salting period .....                                  | 33 |
| 4.6.1 | Identification of critical control point 3.....             | 33 |
| 4.6.2 | Critical limits at critical control point .....             | 33 |
| 4.6.3 | Monitoring procedures at critical control point.....        | 33 |
| 4.6.4 | Corrective actions.....                                     | 33 |
| 4.6.5 | Verification procedures .....                               | 33 |
| 4.6.6 | Documentation and record keeping .....                      | 33 |
| 5.    | REFERENCES .....  | 34 |
|       | ANNEX I Products considered casings.....                    | 35 |
|       | ANNEX II Flowcharts production process natural casings..... | 40 |
|       | ANNEX III Decision Tree to identify CCPs.....               | 42 |
|       | ANNEX IV EU translations of natural sausage casings.....    | 44 |
|       | ANNEX V Applicable EU legislation.....                      | 47 |

## **INTRODUCTION**

### ***1.1 Purpose***

This Community Guide to Good Practice for hygiene and the application of the HACCP principles in the production of natural sausage casings aims to assist producers to put in place, implement and maintain the safe production of natural sausage casings. It enables the natural sausage casing industry to better understand and comply with the legal requirements that are expressed in the Regulation. The primary responsibility for safe production rests with the food business operators.

Although the Community Guide is a voluntary instrument, producers of natural sausage casings are strongly encouraged to use this Community Guide in developing and maintaining their company-specific food safety management system. If Member States and/or operators have implemented higher standards and are applying them, this Community Guide should never be used to lower the level of these standards.

Community guides are subject to periodical review.

### ***1.2 Scope***

For the purpose of this guide, the production process of natural sausage casings was considered from the moment the intestines enter the cleaning process at the slaughterhouse until the natural sausage casings are dispatched to the sausage producers. Therefore, this Community Guide applies to food business operators in different types of establishments, including slaughterhouses and those carrying out sorting operations and distribution centres within the natural sausage casing industry.

Community legislation relevant to the natural sausage casing industry and included in Annex V consists of:

- Regulation (EC) No 178/2002 laying down the general principles and requirements of food legislation;
- Regulation (EC) No 852/2004 on the hygiene of foodstuffs;
- Regulation (EC) No 853/2004 laying down specific hygiene rules for food of animal origin;
- Regulation (EC) No 854/2004 laying down specific rules for the organisation of official controls on products of animal origin intended for human consumption;

- Regulation (EC) No 882/2004 on official controls performed to ensure the verification of compliance with feed and food law, animal health and animal welfare rules;
- Regulation (EC) No 999/2001 laying down the rules for the prevention, control and eradication of certain transmissible spongiform encephalopathies;
- Commission Decision 2007/453/EC, establishing the BSE status of the Member States or third countries or regions thereof according to their BSE risk;
- Council Directive 1998/83/EC, on the quality of water intended for human consumption.

Specific community legislation regarding the animal health status of EU Member States should be considered for the acquisition of and trade in natural sausage casings:

- Council Directive 92/118/EEC, laying down animal health and public health requirements governing trade in and imports into the Community of products not subject to the said requirements laid down in specific Community rules referred to in Annex A (I) to Directive 89/662/EEC and, as regards pathogens, to Directive 90/425/EEC;
- Directive 2003/99/EC, on the monitoring of zoonoses and zoonotic agents, amending Council Decision 90/424/EEC and repealing Council Directive 92/117/EC;
- Council Directive 2003/85/EC, on Community measures for the control of foot-and-mouth disease;
- Commission Decision 2008/855/EC, concerning animal health control measures relating to classical swine fever in certain Member States.

## 2. THE PRODUCTION OF NATURAL SAUSAGE CASINGS

### 2.1 Definition of natural (sausage) casings

*"Casings means intestines and bladders, that after cleaning, have been processed by tissue scraping, defatting and washing, and have been treated with salt"*  
(as included in the OIE Terrestrial Animal Health Code - [Glossary](#))

Additional comments to the definition:

- The intestines and bladders are derived from farmed animals, which comprise of pigs (*Sus scrofa*), sheep (*Ovis aries*), goats (*Capra hircus*), cattle (*Bos taurus*, *Bos indicus*) and horses (*Equus caballus*);
- In EU legislation casings are not defined as such, but they are regarded to be part of the group-definition of treated stomachs, bladders and intestines: *"means stomachs, bladders and intestines that have been submitted to a treatment such as salting, heating or drying after they have been obtained and after cleaning"*.

The main distinction as a food ingredient between the definition of casings and the group-definition presented above is the intended use of the product.

- If the **intended use** is as an **edible food envelope** (e.g. sausage) salting or drying after salting is applicable and the product is considered a **casing**;
- If the intended use is not as an edible food envelope, but it is mixed together with other food ingredients, other treatments are also applicable which change the characteristics of the product making it unusable as a casing.

In this Community Guide to Good Practice (cGGP) the focus lies on natural casings and its specific production steps.

- The following species / organ / treatment combinations are to be regarded as natural casings:

| Species      | Intestine      |                | Bladder |   |
|--------------|----------------|----------------|---------|---|
|              | S <sup>1</sup> | D <sup>2</sup> | S       | D |
| Pig          | X              | X              | X       | X |
| Cattle       | X              | X              | X       | X |
| Sheep / goat | X              | X              |         |   |
| Horse        | X              |                |         |   |

1: salted natural casings

2: dried natural casings (after salting)

Below, references are made to certain EU legal texts. In these references only the treatments relevant to natural casings are included.

- According to Annex I, Regulation (EC) No 853/2004, the official definition of treated intestines is: intestines that have been submitted to a treatment such as salting or drying after they have been obtained and after cleaning;
- The casing industry generally uses the phrase “natural casings” to define intestines that have been processed after cleaning.
  - Cleaning is defined as content removal from the intestine or bladder and rinsing with water;
  - Processing is defined as flushing and / or defatting and / or scraping (removal of internal / external tissue layers).

Subsequent salting for at least 30 days, using dry salt (NaCl) or brine (saturated salt solution, produces the so-called finished product. Only natural casings as finished products will become available for human consumption;

- Cleaned preserved intestines have no official definition in Regulation (EC) No 853/2004 and therefore are regarded as fresh meat. However, cleaned preserved intestines are not consumed as such and therefore the strict (hygiene) requirements applicable to fresh meat need not apply, as these cleaned preserved intestines will be further processed into natural casings;
- A special category of casings are frozen, dried casings, laminated or pasted casings and sewn casings. These casings are specifically developed to meet certain sausage production requirements (e.g. larger diameter than naturally available). They can be considered natural casings only if the original material at any stage during production has been cleaned, processed and salted for 30 days.
- In accordance with the OIE Code definition on casings, animal stomachs derived from the afore mentioned farmed animals, are NOT considered natural casings.
- For a full overview of all products considered casings, please check Annex I.

### **EU import of animal casings**

- Commission Decision 2003/779/EC, laying down animal health requirements and the veterinary certification for the import of animal casings from third countries: In the requirements included on the EU health certificate, animal casings are to be



cleaned, scraped and salted with NaCl for 30 days, as described in the definition of natural casings.

The health certificate, to be signed by the Official Veterinarian at the third-country establishment, does not require the 30 days salting to happen in the third-country establishment sending the natural casings to the EU. As a consequence, if the Official Veterinarian at the third-country establishment sending the natural casings to the EU can confirm that the natural casings were already salted for 30 days at another casing establishment, based on a signed veterinary certificate issued by the Competent Authority in a third country or EU Member State, he / she can sign the health certificate included in Commission Decision 2003/779/EC.

In that case there is no need to restart the 30-day salting period in the third-country establishment prior to sending the natural casings to the EU.

### **Specified Risk Material**

- In accordance with Regulation (EC) No 999/2001 – annex V, the following sections of the intestinal tract from bovine animals shall be designated specified risk material (SRM) and are not intended for human consumption:
  - Bovine animals

The last four meters of the small intestine (including the ileum), the caecum and the mesentery of bovine animals of all ages originating from an EU Member State or a third country with a controlled and undetermined BSE risk status. No SRM restrictions apply to EU Member States with a negligible BSE risk status.

A comprehensive report on the removal of SRM from the bovine intestinal tract and mesentery under slaughterhouse conditions, for animals originating from Member States or third countries with a controlled or undetermined BSE risk is made available since mid-2016 on the DG SANTE website ([LINK](#)), using the SRM pull-down menu. This report includes 5 instruction videos;
- Beef casings can be imported into the EU when derived from animals originating in a country with a negligible, controlled or undetermined BSE risk status (in accordance with Commission Decision 2007/453/EC). This import can be done either directly or via triangular trade, taking into account the SRM restrictions applicable to the country from where the beef casings originate, based on its BSE risk status;

- Due to the fact that the ovine and caprine ileum is no longer considered SRM, the import of sheep and goat casings should be allowed without restriction and additional certification requirements. However, a proposal to amend the related section on the import health certificate will be submitted in 2019. When this will come into force is yet unknown.

### **Trade**

- The relevant CN code 0504 00 00, used for the international trade in natural casings, is described as: *Guts, bladders and stomachs of animals (other than fish), whole and pieces thereof, fresh, chilled, frozen, salted, in brine, dried or smoked.* According to the description, both natural casings (treated intestines) and cleaned preserved intestines are covered by this CN code using the term "guts". In Commission Regulation (EC) No 1549/2006 on the tariff and statistical nomenclature and on the Common Customs Tariff, the word "gut" is used in reference to intestines. The word "casings" is also used but for other products not related to intestines.

Products traded using CN code 4206 00, *articles of gut (other than silk-worm gut), of goldbeater's skin, of bladders, or of tendons,* are not considered natural casings (treated intestines) as these products are not intended for human consumption. Any definition, description or requirement described in this Community Guide for natural casings is therefore not applicable to these non-edible products.

### **2.2 Description of natural casings**

All domestic ungulates farmed for food purposes can be used as a source for natural casings. However, they are predominantly produced from pigs, sheep (goats) and cattle. From pigs the entire intestinal tract is used for the production of casings, specifically the small intestines (duodenum, jejunum, ileum), bung (caecum), large intestines (colon ascendens & transversum), after end (colon descendens) and fat end (rectum). From sheep, the small intestines are used, particularly the duodenum and jejunum and sometimes also the ileum and caecum. The intestinal tract of cattle is also used entirely with the exception of the ileum. Its shape differs too much from the jejunum to produce the classic beef rounds and is therefore removed prior to the cleaning process and destroyed. Beef casings are produced from small intestines (duodenum, jejunum) which are processed into beef rounds, bung (caecum), and from

large intestines (colon) which are processed into beef middles. Beef casings are also produced from the weasand (oesophagus) and bladders.

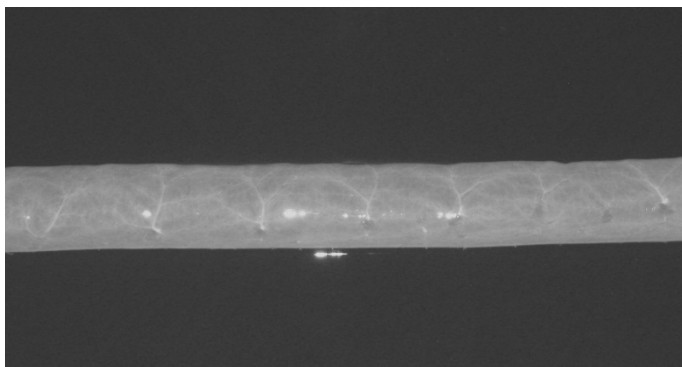
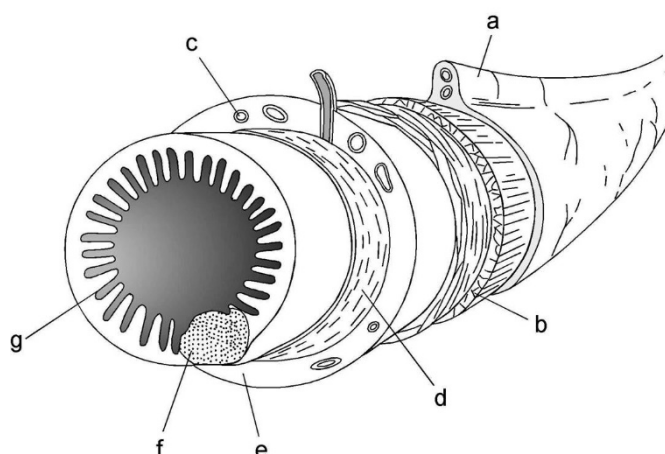

Figure 1: Fully processed sheep casing

Originating from either pig or small ruminants, natural casings consist of the tunica submucosa after the cleaning process is finished. Intestinal mucosa, Peyer's Patches and the outer layers (tunica muscularis and tunica serosa) are removed completely.

Figure 2: Schematic diagram of sheep small intestine showing mesentery and serosa (a), inner and outer muscle layers (b), submucosal blood vessels (c), muscularis mucosae (d), submucosa (e), lymphoid nodule (Peyer's patch) (f), and tunica mucosa (villus and crypt layers) (g). The tunica mucosa, the muscularis, the serosa and Peyer's patches are removed during processing, so the natural casing consists of only the submucosa (e).



When natural casings are produced from cattle intestines, all different tissue layers remain present in the finished product.

During the cleaning process the actual structure of the natural casing is not altered, nor during the subsequent curing and final preservation using salt as preservative agent (either dry-salted or in saturated brine).

Natural casings are stored and transported in closed containers, either in dry salt or fully saturated brine ( $\geq 22$  °Baumé), preferably at temperatures around or below 20 °C without exposure to direct sunlight. Once cleaned, cured and properly salted natural casings can be kept in storage for a prolonged period of time without loss of quality or increased microbiological counts. The shelf life period of natural casings is at least 4 years (ISWG, 2014).

The microbiological recommendations for salted natural casings as incoming product at meat processing establishments (entrance control) are listed in the table below.

**Table 1 Recommendations microbiological values (CFU per gram)<sup>1</sup>**

|                                | Fully acceptable       | Maximum value         | Reference   |
|--------------------------------|------------------------|-----------------------|-------------|
| Total aerobic count            | <1.0 x 10 <sup>5</sup> | 5.0 x 10 <sup>6</sup> | ISO 4833    |
| <i>Enterobacteriaceae</i>      | <1.0 x 10 <sup>2</sup> | 1.0 x 10 <sup>4</sup> | ISO 21528-2 |
| <i>Staphylococcus aureus</i>   | <1.0 x 10 <sup>2</sup> | 1.0 x 10 <sup>3</sup> | ISO 6888-1  |
| <i>Clostridium perfringens</i> | <1.0 x 10 <sup>2</sup> | 1.0 x 10 <sup>3</sup> | ISO 7937    |
| <i>Bacillus cereus</i>         | <1.0 x 10 <sup>4</sup> | 1.0 x 10 <sup>5</sup> | ISO 7932    |

CFU = Colony Forming Units

## 2.3 Processing of natural casings

### 2.3.1 Cleaning operations

#### *Receiving from slaughter line*

After the intestines have been carefully separated from the attached organs (stomach, spleen, etc.) they can be cleaned by a cleaning operation on-site at the slaughterhouse ("gut room") or transported to a cleaning operation elsewhere. Before transportation to a cleaning operation on a different location, the intestines are pulled from the mesentery, applicable SRM removed and the manure is stripped out. These cleaned preserved intestines are transported in chilled water (< 3 °C) or as frozen goods.

#### *Pulling and cleaning*

The cleaning operation starts by placing the intestinal tract on a pulling table after reception from the slaughter line. The intestines are pulled from the mesentery either by hand, with an (air-operated) knife or by a machine depending on the species and processing technique.

From the pulling table the intestines are transferred to the manure stripper, the first step in the casing cleaning line. Casing cleaning equipment consists mainly of conveyor belts, holding (soak) tanks, water sprinklers, rollers and scrapers through which the casings are transported. The holding tanks are operated at temperatures, usually at about 40 °C, because this temperature facilitates the cleaning process. Water sprinklers supply fresh potable water to rinse the casings. The rollers may consist of various materials. A high standard of equipment cleaning and disinfection procedures should be applied here to reduce the risk of cross-contamination with micro-organisms.

<sup>1</sup>Amended (ISWG, 2014)

After manure stripping the intestines go through a series of steps removing the mucosa and muscular and serosa layers (ISWG, 2014). Sheep casings, due to their more delicate structure, are fermented first to facilitate the removal of the different layers. This process may take from one day to a week, depending on the water temperature (21 to 1 °C). Beef casings are turned inside out to facilitate this operation, but pig and sheep intestines are NOT inverted and the loose mucosa is stripped out.

After the finishing machine the casings are cooled off in a cold water bath or a cold salt brine tank to reduce bacterial growth and to wash out any remaining blood. Here the casings are bundled and prepared for the next step.

### *Salting (and Curing)*

The main purpose of the salting and curing process is to reduce the water content in the natural casings and replace it by a high salt concentration. This way little water remains available for bacterial growth and bacteria are actively killed due to the high salt concentrations.

Casings may be salted by hand or with a machine. The bundles of casings may then be left to drain overnight or be centrifuged (dry salting), or directly packed in a container with salt-water brine (slush salting). For dry salting the bundles are shaken to remove salt after curing, and then they are thoroughly rubbed with salt until they absorb the maximum quantity of salt.

When natural casings have been stored in dry salt or saturated brine for a minimum period of 30 days, potentially pathogenic bacteria are no longer present, with the exception of bacterial spores. However, these spores will remain inert as long as the existing storage conditions remain intact and therefore pose little risk (Houben 2005, Wijnker et al. 2006). During this initial 30-day salting period or any other subsequent storage period, no specific storage temperatures are required to obtain the desired bacterial risk reduction.

### *Packing*

Salted natural casings are put in bundles or nets and stored in closed casks. All packaging material (casks, liners etc.) and other products (rings, nets, tubes, etc.) that come directly into contact with the natural casings need to be clean and suitable for use in contact with foodstuffs.

### *Dispatch*

After cleaning the natural casings are either transported to a sorting operation or a distribution centre.

### *2.3.2 Sorting operations*

#### *Receiving*

Sorting operations either receive natural casings from cleaning operations or distribution centres.

#### *Storage/ Transport*

For selection and grading operations, natural casings can be transported to other locations, either stored in dry salt or saturated brine.

#### *Rinsing/ Desalting*

Prior to sorting the natural casings are rinsed in water and de-salted to facilitate these operations.

#### *Selection/ Grading/ Classification*

At selection the calibre, length per strand and quality (e.g. holes) of the natural casings is determined. To assess this, casings are filled with water (small ruminant, hog) or air (ruminant). The calibre is measured with an electronic instrument, a calibre block or a so-called piano. The natural casings are graded in different calibres in steps of 2 to 3 mm.

#### *Salting/ Curing (Dry or in brine)/ Packing*

After selection and grading, the natural casings are re-packed as bundles in dry salt or saturated brine. Alternatively, natural casings can also be shirred manually or mechanically as individual strands on plastic flexible tubes or rigid pipes and packed in saturated brine. This facilitates sausage production as the casings can now be loaded directly onto the sausage filling horn without further handling by the sausage producer. As described under Cleaning Operations, salted natural casings are put in bundles or nets and stored in closed casks.

#### *Dispatch*

After sorting, natural casings are transported to either a distribution centre or directly to the customer.

### *2.3.3 Distribution (repacking) centres*

Distribution centres can receive natural casings from slaughterhouses, cleaning operations or sorting operations. Depending on the kind of establishment where the natural casings come from, a specific process step is executed and the natural casings are transported to the next step in the production chain as described above.

### **3. PREREQUISITE REQUIREMENTS**

Food hygiene is the result of the implementation by food businesses of prerequisite requirements and procedures based on the HACCP principles. The prerequisite requirements provide the foundation for effective HACCP implementation and should be in place before a HACCP based procedure is established (CAC, 1997).

#### ***3.1 Primary production***

Primary production is beyond the scope of this Community Guide to Good Practice.

#### ***3.2 Establishment: design and facilities***

##### ***3.2.1 Location***

The location of the establishments should be carefully chosen and protective measures (e.g. alarm system, guards) should be taken to prevent any threat to food safety or suitability. Production equipment should be located in a way that enables its intended use, adequate maintenance and facilitates good hygiene practices.

Each natural casing establishment will be audited and subsequently approved if it was found to be in accordance with the requirements stipulated in Regulation (EC) No 852/2004 and Regulation (EC) No 853/2004.

##### ***3.2.2 Premises and rooms***

The internal design and layout of food establishments should be easy to maintain and clean and permits good food hygiene practices. Internal structures should be soundly built using durable materials. The surfaces of walls, partitions and floors should be made of impervious materials with no toxic effect to any foodstuffs either handled or produced. Walls and partitions should have a smooth surface up to a height appropriate to the operation. Floors should be constructed to allow adequate drainage and cleaning. Ceilings and overhead fixtures should be constructed and finished to minimize the build-up of dirt and condensation and the shedding of particles, with adequate ventilation. Windows should be easy to clean, constructed to minimize the build-up of dirt and fixed or fitted with removable and cleanable insect-proof screens if windows are intended to be opened.

The internal product flow should be developed in such a way that prevents cross-contamination between "clean" products and "dirty" areas. The design of the establishment should be logical and supportive to this goal.

### *3.2.3 Equipment*

Equipment and containers (other than single-use containers and packaging material) coming into contact with foodstuffs, should be designed and constructed to ensure that, they can be adequately cleaned, disinfected and maintained to avoid the contamination of foodstuffs. For equipment designed for cooling or freezing foodstuffs the temperature should be monitored and controlled as well as the time it takes to reach the right temperature. Measuring devices (e.g. salometer) should be calibrated at least once per year and results recorded and filed.

Containers for waste and inedible substances should be specifically identifiable, suitably constructed and made of impervious material. Containers used to hold dangerous substances should be identified and are kept locked when not in use to prevent malicious or accidental contamination of foodstuffs.

### *3.2.4 Facilities*

In the natural casings industry appropriate facilities should be used for an adequate supply of potable water. Where non-potable water is to be used (e.g. fire control) it should run through a separate system that is clearly identified and not connected with, or allowed to reflux into, the potable water system. Adequate drainage and waste disposal systems and facilities should be designed and constructed in such a way to avoid the risk of contaminating foodstuffs or the potable water supply. Adequate facilities, suitably designated, should be provided with hot and/or cold potable water for cleaning of utensils and equipment.

Facilities for personal hygiene and lavatories should be suitably located and designated. Lavatories should be of appropriate hygienic design and adequate changing facilities for personnel should be available. Wash basins with a supply of hot and cold (or suitably temperature controlled) water for hygienically washing of hands, materials for cleaning hands, and facilities for drying of hands should be easily accessible.

Ventilation systems should be installed to control ambient temperatures and to control humidity and to ensure the safety and suitability of foodstuffs. Ventilation systems should be designed and constructed so that air does not flow from contaminated areas to clean areas and allow for adequate maintenance and cleaning.

Adequate natural or artificial lighting (intensity, colour) suitable to the nature of the operation should be provided. Lighting fixtures should be protected to ensure that foodstuffs are not contaminated by breakages in areas where open, unpacked foodstuffs are handled.



Adequate facilities for the separate storage of natural casings, ingredients and non-food chemicals (e.g. cleaning materials, lubricants) should be provided.

### ***3.3 Control of operation***

#### *3.3.1 Control of food hazards*

The natural casing industry controls food hazards through the use of the HACCP system. The application of the HACCP system in the natural casing industry is described in section 4.

#### *3.3.2 Key aspects of hygiene control systems*

Until natural casings have been salted for the first time, it is necessary to maintain storage in cooled areas (max. 3 °C). Systems should be in place to ensure that temperature is controlled effectively where it is critical to the safety and suitability of foodstuffs (see §3.2.3).

Measures should be taken to prevent cross-contamination between cleaned preserved intestines and salted natural casings, e.g. separation (physically or by time), (intermediate) cleaning / disinfection, personal hygiene.

There should be systems in place to prevent the physical and chemical contamination of natural casings (e.g. knife policy, glass policy, pallet policy).

#### *3.3.3 Incoming material requirements*

All natural casings or cleaned preserved intestines should come from EU-approved establishments, either located in EU Member States or in third countries that show compliance with the EU legislation. All suppliers of incoming goods should be listed. All incoming goods should be registered and inspected before processing. Stocks should be controlled by an effective stock rotation system such as "first in, first out" (FIFO).

#### *3.3.4 Packaging*

The packaging design and materials should provide adequate protection for natural casings to minimize contamination, prevent damage and accommodate proper labelling. Only food grade packaging materials should be allowed. Reusable packaging should be suitably durable, easy to clean and disinfected.

#### *3.3.5 Water*

Only potable water should be used in the handling and processing of natural casings. Ice used should be produced from potable water and protected from contamination during production, handling and storage. Quality tests on the water used for the

production of foodstuffs should be done in accordance to the parameters and frequencies listed in Council Directive 1998/83/EC.

#### *3.3.6 Management and supervision*

The type of control and supervision should be sufficient to ensure food safety and suitability. Managers and supervisors should be sufficiently trained on food hygiene principles and practices to be able to judge potential risks, take appropriate preventive and corrective action, and ensure that effective monitoring and supervision takes place.

#### *3.3.7 Documentation and records*

Records of processing, production and distribution should be kept and retained for a period that exceeds the shelf-life of the product of at least one year. A minimum shelf-life of 4 years has been established for salted natural casings (ISWG, 2014).

#### *3.3.8 Product traceability procedures*

In accordance to Regulation (EC) No 178/2002, there should be effective procedures in place in case of a food safety hazard to enable the complete, rapid recall of any implicated lot (traceability one step up and one step down in the production chain), to deal with the effect, and carry out other necessary measures (e.g. informing the competent authorities, safety evaluation for other lots, public warnings).

### **3.4 Establishment: maintenance and sanitation**

#### *3.4.1 Maintenance and cleaning*

Establishments and equipment should be kept in an appropriate state of repair and condition by the implementation of a maintenance plan. Cleaning of the workshops and premises should be done according to an implemented cleaning and disinfection programme. The maintenance plan and cleaning and disinfection programme should prevent contamination (physical, chemical, biological) of the natural casings.

#### *3.4.2 Cleaning programme*

The cleaning and disinfection programme should ensure that all parts of the establishment are appropriately clean, including cleaning equipment. To monitor the suitability and effectiveness of the cleaning activities periodical verification should be done via hygiene inspections (e.g. daily) and microbiological sampling (e.g. weekly).

### *3.4.3 Pest control systems*

Buildings should be kept in good repair and condition to prevent pest access and to eliminate potential breeding sites. Holes, drains and other places where pests are likely to gain access are to be kept sealed. Doors and windows should be kept closed or covered with e.g. wired mesh screens or plastic curtains. Ventilators should be covered with nets. Animals should be excluded from the premises.

Potential food sources should be stored in pest-proof containers and/or stacked above the ground and away from walls. Areas inside and outside the establishments should be kept clean and should be regularly examined for evidence of infestation. Animal by-products and refuse should be stored in covered, pest-proof containers.

Pest infestation should be dealt with immediately and without adversely affecting food safety or suitability. Treatment with chemical, physical or biological agents should be carried out without posing a threat to the safety or suitability of foodstuffs.

### *3.4.4 Waste management*

A suitable provision should be made for the removal and storage of waste. There should be no accumulation of waste in production areas. Waste stores should be kept appropriately clean. Waste should be stored separate from any foodstuffs to avoid cross-contamination.

### *3.4.5 Monitoring effectiveness*

Sanitation systems should be periodically monitored for effectiveness (e.g. daily pre-operational inspection, weekly microbiological sampling) and when appropriate, procedures and work instructions should be adjusted and corrective actions taken.

## **3.5 Establishment: personal hygiene**

### *3.5.1 Health status*

Personnel and visitors known, or suspected, to be suffering from, or to be a carrier of a disease or illness likely to be transmitted through foodstuffs, are not allowed to enter the production area if there is a likelihood of foodstuff contamination by these persons. Any person so affected immediately reports his/her illness or symptoms of illness to the management.

Conditions that must be reported to management are: jaundice, diarrhoea, vomiting, fever, sore throat with fever, visibly infected skin lesions (boils, cuts, etc.), discharges from the ear, eye or nose. Medical examination of a food production employee should be carried out if clinically or epidemiologically indicated.

### *3.5.2 Personal cleanliness and behaviour*

Personnel and visitors should maintain a high degree of personal cleanliness and wear suitable protective clothing, head covering, and footwear in production areas. Cuts and wounds, where personnel are permitted to continue working, should be covered by suitable waterproof dressings.

Personnel and visitors should wash their hands when personal cleanliness may affect food safety (e.g. at the start of foodstuff handling activities, before and after each break, after toilet use). Visible personal items (e.g. jewellery and watches) are not allowed in production areas. Behaviour that could result in contamination of foodstuffs (e.g. smoking, spitting, chewing or eating) is not allowed in the production area.

### **3.6 Transportation**

Products should be transported in closed packaging. All vehicles used for transportation of raw, semi-processed or finished products to and from the premises should be suitable for their purpose (e.g. closed, climate-controlled) and kept in an appropriate state of cleanliness, repair and condition.

Where conveyances and/or containers are used for transporting anything in addition to foodstuffs or for transporting different foodstuffs at the same time, there is, where necessary, to be effective separation of products or effective cleaning between loads to avoid the risk of contamination.

### **3.7 Product information**

Each outgoing shipment should be permanently labelled according to Regulation (EC) No 853/2004 in order to identify the producer and the lot and to recall the lot if necessary.

Each product container should be accompanied by or bears adequate information to enable the next person in the food chain to handle the product safely and correctly.

### **3.8 Training**

All (temporary) personnel engaged in foodstuff operations who come directly or indirectly into contact with foodstuffs should be trained, and/or instructed in food hygiene principles and practices to a level appropriate to the operations they are to perform (e.g. on-the-job training by supervisor, external training programme for all personnel every 2 years).

Designated personnel should be trained in handling strong cleaning chemicals or other potentially hazardous chemicals safely.

There should be annual assessments of the effectiveness of training and instruction programmes, as well as routine supervision and checks to ensure that procedures are being carried out effectively. Training programmes should be reviewed at least once per year and updated if appropriate. Repeated training programmes ensure that all food production employees remain aware of all procedures and the necessary knowledge and skills to maintain the safety and suitability of foodstuffs.

## 4. HACCP PLAN FOR THE PRODUCTION OF NATURAL CASINGS

### 4.1 Hazard Identification

The HACCP system is not a replacement for other food hygiene requirements, but a part of a package of food hygiene measures that must ensure food safety. Potential biological, chemical and physical hazards in the production of natural casings are listed below in table 2 (CAC, 1997; ILSI, 2004).

#### 4.1.1 Biological hazards

In the production of natural casings several bacteria, viruses and parasites can form a threat to food safety (Table 2).

**Table 2 Biological hazards in the production of natural casings**

| Hazard                         | Relevant |
|--------------------------------|----------|
| <b>Bacteria</b>                |          |
| <i>Bacillus cereus</i>         | Yes      |
| <i>Clostridium botulinum</i>   | Yes      |
| <i>Clostridium perfringens</i> | Yes      |
| <i>Listeria monocytogenes</i>  | Yes      |
| <i>Escherichia coli</i>        | Yes      |
| <i>Salmonella spp.</i>         | Yes      |
| <i>Staphylococcus aureus</i>   | Yes      |
| <b>Viruses</b>                 |          |
| All viruses                    | Yes      |
| BSE prions/ scrapie            | Yes      |
| <b>Parasites</b>               |          |
| <i>Trichinella spiralis</i>    | No       |
| Ascariasis                     | No       |
| Cysticercosis                  | No       |
| Toxoplasmosis                  | Yes      |

*Bacillus cereus*, *Clostridium botulinum* and *Clostridium perfringens* can be present in soil or faeces and are capable of producing endospores. *Listeria monocytogenes* can also be present in soil, environment, people and faeces. Natural casings can be contaminated with *Escherichia coli* and *Salmonella spp.* through faeces, environment, people, pests etc. *Staphylococcus aureus* may occur as a commensal on human skin and thereby contaminate the natural casings during handling.

Viruses are generally transferred from person to person. Foodstuffs can accidentally become carrier without being the primary source.

To prevent, control and eradicate certain transmissible spongiform encephalopathies, designated Specific Risk Material (SRM / Regulation (EC) No 999/2001) is not used for the production of natural casings, based on the BSE risk status of the animal's country of origin, from which the natural casings are derived.

Porcine and ruminant intestinal parasites (e.g. *Trichinella*, *Ascariasis*, *Cysticercosis*) do not form a threat to food safety as cleaned natural casings do not contain any infectious stage of these parasites. However, *Toxoplasmosis*, which can be incidentally transmitted via pigs, may possibly pose a risk.

#### 4.1.2 Chemical hazards

The possible chemical hazards in the natural casing industry can be subdivided into chemical residues in the primary product and contamination with chemicals during the production process of natural casings. Examples of potential chemical hazards are listed in Table 3.

**Table 2 Chemical hazards in the production of natural casings**

| <b>Hazard</b>                                  | <b>Relevant</b> |
|--|-----------------|
| <i>Chemical residues in primary product</i>    |                 |
| Herbicides, pesticides and insecticides        | No              |
| Dioxins, furans, PCBs                          | No              |
| Heavy Metals                                   | No              |
| Antibiotics                                    | No              |
| Hormones                                       | No              |
| Melamine                                       | No              |
| <i>Contamination during production process</i> |                 |
| PAHs   | No              |
| Nitrate/ Nitrite                               | No              |
| Heavy Metals                                   | No              |
| Colorants                                      | No              |
| Lubricants                                     | No              |
| Cleaning and disinfection agents               | No              |
| Coolants                                       | No              |
| Toxins from packaging material                 | No              |

### *Chemical residues in the primary product*

Herbicides, pesticides and insecticides are not allowed to be used in animal husbandry. Dioxins, furans and polychlorinated biphenyls (PCBs) accumulate in the fatty tissue, but the Tolerable Weekly Intake (TWI) value of 14 pg WHO-TEQ/kg body weight (bw) will not be exceeded because cleaned casings contain less than 2% fatty tissue (Commission Regulation (EC) No 1881/2006; ISWG, 2014).

Residue of heavy metal is unlikely because intestinal tissue layers do not store heavy metals (Osweiler, 1996).

To prevent residues of antibiotics and hormones only registered Veterinary Medicinal Products (VMPs) are allowed in animal husbandry and appropriate withdrawal periods are taken in regard prior to slaughter (Regulation (EC) No 470/2009, Annexes I to IV of Council Regulation (EEC) No 2377/90).

The recommended Tolerable Daily Intake (TDI) for melamine is 0.5 mg/kg b.w. per day. Melamine could not be detected in tissue samples taken from animals that consumed feed contaminated with melamine. This situation also applies to natural casings (EFSA, 2007).

### *Chemical contamination during the production process*

Polycyclic aromatic hydrocarbons (PAHs) are not likely to be present because natural casings are not scorched or burned during processing.

Nitrate and nitrite are not allowed for the processing of natural casings (Regulation (EC) No 1333/2008).

The salt used for processing natural casings is food grade and therefore does not contain any heavy metals above agreed maximum limits (CAC, 1985).

Applied colorants in natural casings shall comply with the requirements stipulated in Regulation (EC) No 1333/2008.

Lubricants used during the processing of natural casings are Food Grade Lubricants. Only cleaning agents and disinfectants approved for application in the food industry (in accordance to Regulation (EC) No 648/2004 on detergents) are used with adequate cleaning and disinfection procedures (§3.4.1 and §3.4.2).

Direct contact between the natural casings and coolants is prevented (e.g. by placing the entire cooling system outside production areas).

Only packaging material and production equipment which meet food grade qualifications (Regulation (EC) No 1935/2004 and Commission Regulation (EC) No 10/2011) should be allowed to come into contact with natural casings in order to prevent migration and subsequent contamination of the foodstuff with potential toxins.



During production, all packaging material is checked prior to use on absence of any physical contamination.

According to all information provided above there, are no relevant chemical hazards in the production of natural casings.

#### 4.1.3 Physical hazards

During processing of natural casings there are several physical hazards to consider. The anatomy of the intestines rules out normal presence of bone and any incidental contamination of the natural casings with bone will be detected and removed during processing (ISWG, 2014). Pests and their excrements are a potential source of physical contamination. Insufficient hygiene of employees / visitors could cause product contamination by employees and visitors (e.g. hair). Foreign objects (e.g. glass, wood, metal) are potentially harmful and due to the usage of foreign objects in the production area contamination is a possibility. The salt used for processing natural casings is food grade and therefore highly unlikely to contain small stones and sand.

**Table 3 Physical hazards in the production of natural casings**

| <b>Hazard</b>  | <b>Relevant</b> |
|--|-----------------|
| <i>Physical residues in primary product or contamination during production process</i> |                 |
| Bone fragments (animal)  | No              |
| Pests/ -excrements   | Yes             |
| Hair (human)   | Yes             |
| Glass  | Yes             |
| Wood   | Yes             |
| Metal  | Yes             |
| Plastics   | Yes             |
| Paper  | Yes             |
| Small stones   | No              |
| Sand   | No              |

#### 4.2 Hazard Analysis

All biological, chemical and physical hazards in the production of natural casings are evaluated according to the Risk Matrix (Table 5) and the "Decision Tree to identify CCPs". Depending on their severity and probability of occurrence significant hazards are either classified as Moderate risk requiring a Prerequisite Control Measure (PCM) or High risk requiring a Critical Control Point (CCP).

**Table 4 Risk Matrix**

| CHANCE<br>X<br>SEVERITY | Practically impossible             | Very unlikely                      | Unlikely                            | Possible                        | Probable                         | Likely                            | Highly likely                    |
|-------------------------|------------------------------------|------------------------------------|-------------------------------------|---------------------------------|----------------------------------|-----------------------------------|----------------------------------|
|                         | < 1 consumer affected per 50 years | < 1 consumer affected per 10 years | 1-5 consumers affected per 10 years | < 2 consumers affected per year | 2-10 consumers affected per year | 10-50 consumers affected per year | > 50 consumers affected per year |
| Fatal                   | Acceptable risk                    | Moderate risk                      | High risk                           | High risk                       | High risk                        | High risk                         | High risk                        |
| Very severe             | Acceptable risk                    | Acceptable risk                    | Moderate risk                       | High risk                       | High risk                        | High risk                         | High risk                        |
| Severe                  | Acceptable risk                    | Acceptable risk                    | Acceptable risk                     | Moderate risk                   | High risk                        | High risk                         | High risk                        |
| Less severe             | Acceptable risk                    | Acceptable risk                    | Acceptable risk                     | Acceptable risk                 | Moderate risk                    | High risk                         | High risk                        |
| Discomfort              | Acceptable risk                    | Acceptable risk                    | Acceptable risk                     | Acceptable risk                 | Acceptable risk                  | Moderate risk                     | High risk                        |

#### 4.2.1 Biological hazards

There are various situations in which microbiological contamination of natural casings is likely to be at, remain at or increase to unacceptable levels. These situations are listed in Table 6 and will be discussed below.

Insufficient cleaning and disinfection may increase microbiological contamination. According to the risk matrix it is a moderate risk and for this reason there is a cleaning and disinfection procedure to prevent this hazard (See §4.3, PCM1).

Pests are a potential source of microbial contamination and are considered a moderate risk. Effective pest control measures are therefore indicated (See §4.3, PCM2).

Insufficient hygiene of employees/ visitors could cause product contamination by employees and visitors. Because of the moderate risk a control measure is taken (See §4.3, PCM3).

Another moderate risk is the insufficient separation of the product flow that can lead to microbial (re-)contamination of products. Strict separation of products prevents cross-contamination and is a control measure (See §4.3, PCM4).

Contaminated water is potentially harmful and according to the risk matrix a moderate risk and therefore a control measure is required (See §4.3, PCM7).

The maximum storage temperature of untreated casings is defined in Regulation (EC) No 853/2004, Section XIII. However, insufficient cooling is regarded as a moderate risk due to the unlikely chance of consumer exposure to untreated casings. Therefore a control measure is applicable (See §4.3, PCM8).

According to Annex V, Regulation (EC) No 999/2001 (e.g. ileum) and taking into account the BSE risk status of the animal's country of origin (Commission Decision 2007/453/EC), the presence of Specified Risk Material (SRM), after the intestines are

pulled from the mesentery is a hazard with a potential high risk. Therefore according to the decision tree removal of SRM during pulling is a CCP (See §4.4, CCP1).

All bacteria listed in Table 2 are killed when exposed to a water activity ( $A_w$ ) level below 0.83 for 30 days without cooling. Bacterial spores can survive these conditions but remain inactive (ISWG, 2014). Therefore natural casings are preserved in either dry-salt or saturated brine with  $A_w$  levels between 0.80-0.75 for at least 30 days. The salting itself (concentration) and the salting period are both crucial in the elimination of the microbiological contamination. Insufficient preservation at salting and an insufficient preservation period at dispatch to sausage producers are therefore classified as a high risk and a CCP (See resp. §4.5 CCP2 and §4.6 CCP3).

Toxoplasmosis is regarded a parasitic zoonosis according to Directive 2003/99/EC, on the monitoring of zoonoses and zoonotic agents, and therefore its presence in foodstuffs need to be prevented. However, according to a study by Dubey (1997) and the 2007 EFSA opinion on surveillance and monitoring of *Toxoplasma* in humans, food and animals, a salt concentration > 6% is sufficient to destroy its cysts and remove any infectivity. This concentration is well covered when natural casings are preserved in either dry-salt or saturated brine. No additional control measure or CCP is therefore indicated.

**Table 5 Risks for microbiological contamination and their classification and control**

| <b>Risk</b>  | <b>Risk "size"</b> | <b>PCM* or CCP**</b> |
|--|--------------------|----------------------|
| <i>Microbiological contamination is at, remains at or increases to unacceptable levels because of:</i> |                    |                      |
| insufficient cleaning and disinfection   | Moderate           | PCM1                 |
| presence pests   | Moderate           | PCM2                 |
| insufficient hygiene of employees/ visitors  | Moderate           | PCM3                 |
| cross-contamination by insufficient separation of product flow   | Moderate           | PCM4                 |
| contaminated water   | Moderate           | PCM7                 |
| storage temperature  | Moderate           | PCM8                 |
| presence of Specific Risk Material   | High               | CCP1                 |
| insufficient salting   | High               | CCP2                 |
| insufficient salting period  | High               | CCP3                 |

\* Prerequisite Control Measure; \*\* Critical Control Point

#### 4.2.2 Physical hazards

According to the Risk Matrix pests and their excrements are considered a moderate physical risk during processing, storage and transport. Effective pest prerequisite control measures are therefore indicated (See §4.3, PCM2).

Physical contamination of the natural casings through insufficient hygiene of employees / visitors is considered a moderate risk and a prerequisite control measure is taken (See §4.3, PCM3).

**Table 6 Risks for physical contamination and their classification and control**

| <b>Risk</b>  | <b>Risk "size"</b> | <b>PCM* or CCP**</b> |
|--|--------------------|----------------------|
| <i>Physical contamination during production process through:</i> |                    |                      |
| pests/ -excrements   | Moderate           | PCM2                 |
| insufficient hygiene of employees/ visitors (e.g. human hair)    | Moderate           | PCM3                 |
| glass in production area   | Moderate           | PCM5                 |
| wood in production area  | Moderate           | PCM5                 |
| metal in production area   | Moderate           | PCM5                 |
| plastics in production area                                      | Moderate           | PCM5                 |
| paper in production area   | Moderate           | PCM5                 |
| technical malfunctions   | Moderate           | PCM6                 |

\* Prerequisite Control Measure; \*\* Critical Control Point

The presence of foreign objects in the production area (e.g. glass, wood, metal) is evaluated as a moderate risk. As a prerequisite control measure the natural casings are constantly visually checked during the production process and several policies are implemented (See §4.3, PCM5). Technical malfunctions may present an increased risk on foreign objects. A prerequisite control measure ensures regular inspection rounds and maintenance of the building and machinery and limits this risk to an acceptable level (See §4.2, PCM6).

### **4.3 Prerequisite Control Measures**

#### *PCM1 Cleaning and disinfection procedure*

Cleaning and disinfection is done according to agreed procedures. Daily checks aided by checklists and weekly checks with sampling are carried out by the responsible person. Where necessary corrective action such as re-cleaning, rinsing or new instructions for cleaning employees can be taken. Checks and corrective actions are recorded and evaluated.

#### *PCM2 Pest control*

To control pests effectively, periodical checks of baits, screens and lamps (e.g. weekly) are carried out by the responsible person. When presence of pests (e.g. excrements) is confirmed, the frequency of checks will be increased and / or control measures

adapted to enhance efficiency as corrective actions. Checks and corrective actions are recorded and evaluated.

*PCM3 Hygiene of employees/ visitors*

Employees are required to follow the hygiene instructions and work instructions. A specific visitor's policy applies. All visitors, including personnel from third party contractors, are recorded and required to follow the hygiene instructions.

Daily checks by the responsible person assure there is sufficient hygiene or corrective actions are taken. Corrective actions consist of instruction and training of employees or denying entrance to visitors. Checks and corrective actions are recorded and evaluated.

*PCM4 Strict separation of products*

To prevent cross-contamination no product cross flow may occur. A daily check by the responsible person must assure that distance between processing in space and/or time is, where necessary, preserved. As corrective actions, products can be blocked from availability for further production or sales and instruction and training of employees or supervision can be carried out. Checks and corrective actions are recorded and evaluated.

*PCM5 Foreign objects*

There is a continuous visual control on the presence of foreign bodies. Every employee is instructed to identify and segregate any product containing foreign objects and has the authority to block these products from availability for further production or sales when foreign bodies are present.

To prevent product contamination with glass all glass present in production areas is recorded in a Glass Policy.

The usage of metal in production areas is limited to registered knives only. To prevent product contamination with metal a knife policy prescribes these knives are registered per person and each day returned to the Production Desk.

All wood used in production areas is recorded in the Pallet Policy. All wooden pallets are regularly checked for damage and repaired or destroyed if not repairable. Usage of wooden pallets in the production area is limited and strictly supervised to prevent cross-contamination.

There is a zero-tolerance on the presence of foreign objects. Corrective actions can be the removing of foreign objects or goods can be blocked. Goods can be destructed by

the order of a responsible person. Daily checklist and monthly visual checks are carried out. Checks and corrective actions are recorded and evaluated.

#### *PCM6 Technical provisions*

Preventive maintenance of the building and machinery and monthly inspections by a responsible person with a checklist will limit this risk to an acceptable level. As a corrective action malfunctions are repaired immediately. Checks and corrective actions are recorded and evaluated.

#### *PCM7 Water quality*

Only potable water is used, directly from the supplier. Quarterly water samples are taken by the supplier and company. A quality report is issued by the water supplier and water samples are analysed, in accordance to Council Directive 98/83/EC. Corrective actions depend on the hazard. Checks and corrective actions are recorded and evaluated.

#### *PCM8 Storage temperature*

When natural casings are not salted, either in dry salt or saturated brine ( $\geq 22$  °Baumé) they must be stored or transported at a temperature of not more than 3 °C. The temperature of either the storage or transport unit is checked regularly and recorded. As a corrective action any technical malfunction to the storage or transport unit is repaired immediately and recorded.

### **4.4 CCP 1 Removal of SRM**

#### *4.4.1 Identification of critical control point 1*

The presence of Specified Risk Material (SRM) after pulling is a hazard with a high risk. Therefore, according to the decision tree the removal of SRM during pulling is a CCP. The ileum of small ruminants and the last four meters of the small intestine, the caecum and the mesentery of the bovine intestinal tract is designated as SRM.

#### *4.4.2 Critical limits at critical control point*

There is a zero tolerance on the presence of SRM in natural casings.

#### *4.4.3 Monitoring procedures at critical control point*

The cleaning supervisor executes daily regular visual controls of the SRM to make sure all of it is removed.

- After pulling the sheep or goat casings from the mesentery, the ileum is separated from the small intestines and marked for destruction. Daily production is divided into batches based on a fixed time period. The number of ilea removed per period

must match the number of sets pulled from the mesentery. One set contains the entire length of small intestines removed per animal. Optimally it consists of one end.

- For the production of beef casings the situation is more complex as three specified parts need to be separated and destroyed. However, a similar approach as used for sheep casings can be applied (division in batches / time unit), as the individual number of removed small intestinal four meter sections, caeca and mesentery must match the number of sets (beef rounds / beef middles) produced.

A comprehensive report on the removal of SRM from the bovine intestinal tract and mesentery under slaughterhouse conditions, for animals originating from Member States or third countries with a controlled or undetermined BSE risk is made available since mid-2016 on the DG SANTE website ([LINK](#)), using the SRM pull-down menu. This report includes 5 instruction videos.

#### *4.4.4 Corrective actions*

When SRM is not completely removed, the matching batch is designated for destruction. The pulling procedure is examined for the cause of the incomplete removal of SRM and corrected. The processing manager should further investigate the origin of the problem.

#### *4.4.5 Verification procedures*

Annual audits on the results of production procedures and monitoring procedures are taken. Evaluation of production procedures and monitoring procedures may lead to the adjustment of procedures.

#### *4.4.6 Documentation and record keeping*

Record keeping, using a process control checklist, is done on:

- the number of sets produced per day,
- the number of ilea (sheep & goat),
- small intestinal four meter sections, caeca and mesentery (cattle) which are to be condemned and possible corrective actions taken.

### **4.5 CCP 2 Salting**

#### *4.5.1 Identification of critical control point 2*

Microbiological contamination of the natural casings is according to the risk matrix a high risk. This hazard is eliminated by salting and therefore salting is a CCP. There are

two ways of salting that are both covered in this CCP, dry salting and the usage of brine.

#### *4.5.2 Critical limits at critical control point*

As a result of the dry salting process visible salt crystals should be present on the cleaned natural casings at inspection to ensure sufficient saturation. The salt concentration in brine should be at least 22 °Baumé.

#### *4.5.3 Monitoring procedures at critical control point*

The CCP can be monitored at two distinctly separate production steps:

1. During salting and packing (see flow charts in Annex II) where salt or freshly produced brine is added to the natural casings;
2. During the entrance inspection when the salted natural casings are received from a cleaning or sorting operation (see flow charts in Annex II).

In essence the same critical limits apply in both situations. Therefore, the same CCP can be applicable to both situations or two CCPs can be designated as the corrective actions, documentation and record keeping can be different for each specific situation. A specifically assigned, qualified operator monitors the (automated) brine production several times a day (e.g. using a salometer).

Checking of casks during entrance inspection is a statistical process; the number of casks to be checked cannot be prescribed. For dry salting, a visual inspection should show visible salt crystals homogeneously spread over the natural casings.

#### *4.5.4 Corrective actions*

When the salt content drops below the critical limit, all natural casings salted between the last measurement with a correct result and the moment the transgression of the limit was detected, should be re-inspected / re-measured and if necessary salt should be added. At the same time, the salting procedure is examined for the cause of the lack of salt. The processing manager should further investigate the origin of the problem and take corrective action.

#### *4.5.5 Verification procedures*

Annual audits on the results of production procedures and monitoring procedures are taken. Evaluation of production procedures and monitoring procedures may lead to the adjustment of procedures.



#### *4.5.6 Documentation and record keeping*

The daily measurement / inspection results and possible corrective actions are recorded on the process control checklist and entrance inspection forms.

### **4.6 CCP 3 Salting period**

#### *4.6.1 Identification of critical control point 3*

Microbiological contamination of the natural casings is according to the risk matrix a high risk. Apart from salting (CCP2) the natural casings correctly, the salting period is of great importance to eliminate a possible microbiological contamination. Natural casings are required to be salted with NaCl (dry salt or saturated brine) during a continuous period of at least 30 days before they are dispatched to sausage producers. This 30-day period can start as soon as the natural casings are salted at a cleaning operation and can include any storage or transport period before being finally shipped to the sausage producers. However, the possible risk will not become apparent to the consumer as natural casings are generally not consumed as such but are produced into sausages. Therefore the CCP is applicable in a sorting or distribution operation, not a cleaning operation.

#### *4.6.2 Critical limits at critical control point*

At least 30 days. In practice this period of 30 days will be covered by the period needed for storage, dispatch and transport of the natural casings.

#### *4.6.3 Monitoring procedures at critical control point*

Before any batch of natural casings is dispatched, the duration of the salting period is checked by a qualified operator based on the documents that accompany the natural casings concerned.

#### *4.6.4 Corrective actions*

When the period after salting has not exceeded the minimally required 30 days the natural casings have to be stored until the 30 days have passed.

#### *4.6.5 Verification procedures*

Annual audits on the results of monitoring, monitoring procedures and corrective actions are taken and may lead to the adjustment of procedures.

#### *4.6.6 Documentation and record keeping*

The day of salting of a batch of natural casings has to be recorded in documents that accompany the casings during storage and transport.

## 5. REFERENCES

- Codex Alimentarius Commission, 1985. Codex Standard for food grade salt. CX STAN 150-1985, Rev. 1-1997, Amend. 3-2006.
- Codex Alimentarius Commission, 1997. Recommended International Code of Practice - General principles of Food Hygiene. CAC/RCP 1-1969 (Rev.4-2003). Hazard Analysis and Critical Control Point (HACCP) System and Guidelines for its Application. *Annex to CAC/RCP 1-1969 (Rev.4-2003)*
- Dubey, J.P., 1997. Survival of *Toxoplasma gondii* tissue cysts in 0.85-8% NaCl solutions at 4-20 C. *Journal of Parasitology* 83, 946-949.
- EFSA, 2007. Surveillance and monitoring of *Toxoplasma* in humans, food and animals. EFSA-Q-2007-038.
- EFSA, 2007. Provisional statement on a request from the European Commission related to melamine and structurally related compounds such as cyanuric acid in protein-rich ingredients used for food and feed. EFSA-Q-2007-093.
- Houben, J.H., 2005. A survey of dry-salted natural casings for the presence of *Salmonella spp.*, *Listeria monocytogenes* and sulphite-reducing *Clostridium* spores. *Food Microbiology* 22, 221-225.
- International Life Sciences Institute, 2004. A simple guide to understanding and applying the HACCP concept. 3<sup>rd</sup> edition. ISLI Press Washington, USA.
- International Scientific Working Group (ISWG), 2014. Scientific Research on Natural Sausage Casings – Second Edition (Kersting, H.M., Leymonie, P., Wijnker, J.J., Eds.). ISWG, Alexandria.
- Osweiler, G.D, 1996. Toxicology. Nat. Vet. Medical Series, Williams and Wilkins, Baltimore, USA.
- Wijnker, J.J., Koop, G., Lipman, L.J.A, 2006. Antimicrobial properties of salt (NaCl) used for the preservation of natural casings. *Food Microbiology*, 23, 657-662.

## ANNEX I Products considered casings

*Table 1 and figure 1*

| Product name          | Anatomical reference  | Reference number |
|-----------------------|---|------------------|
| <b>Porcine origin</b> |   |                  |
| Hog casing            | Casings prepared from the duodenum, jejunum and ileum of pigs (hogs)  | <b>1</b>         |
| Hog cap or blind gut  | Casings prepared from the blind gut (caecum) of pigs  | <b>2</b>         |
| Chitterling           | Casings prepared from the proximal part of the large intestines of pigs (hogs), starting at the blind gut up to the bung or after end, striated in shape, approx. 3 m in length | <b>3</b>         |
| After end             | Casings prepared from the distal part of the large intestines of pigs (hogs), starting at the chitterling up to the fat end, straight in shape, approx. 1 m in length           | <b>4</b>         |
| Fat end               | Casings prepared from the distal part of the large intestines of pigs (hogs), starting at the after end up to the rectum, conical in shape, approx. 1 m in length               | <b>5</b>         |
| Bung                  | Distal part of the large intestines of pigs (hogs) up to the rectum, comprising of after-end and fat end  | <b>6</b>         |
| Bladders              | Casings prepared from the urinary bladder of pigs   | <b>7</b>         |

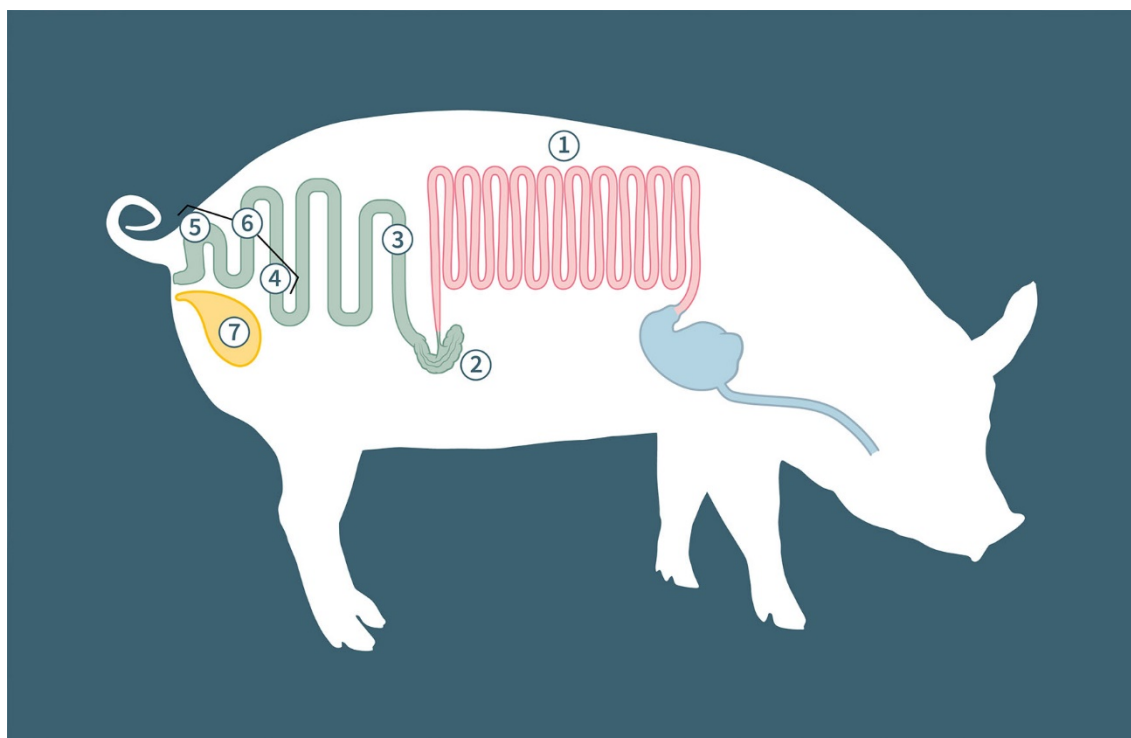

Hog casings

**Table 2 and figure 2**

| Product name        | Anatomical reference  | Reference number |
|---------------------|---|------------------|
| <b>Ovine origin</b> |   |                  |
| Sheep casing        | Casings prepared from the duodenum, jejunum and ileum of sheep  | <b>1</b>         |
| Bung end            | Casings prepared from the proximal part of the blind gut (caecum) of sheep, connected to the large intestines | <b>2</b>         |
| Bung cap            | Casings prepared from the most distal part of the blind gut (caecum) of sheep                                 | <b>3</b>         |

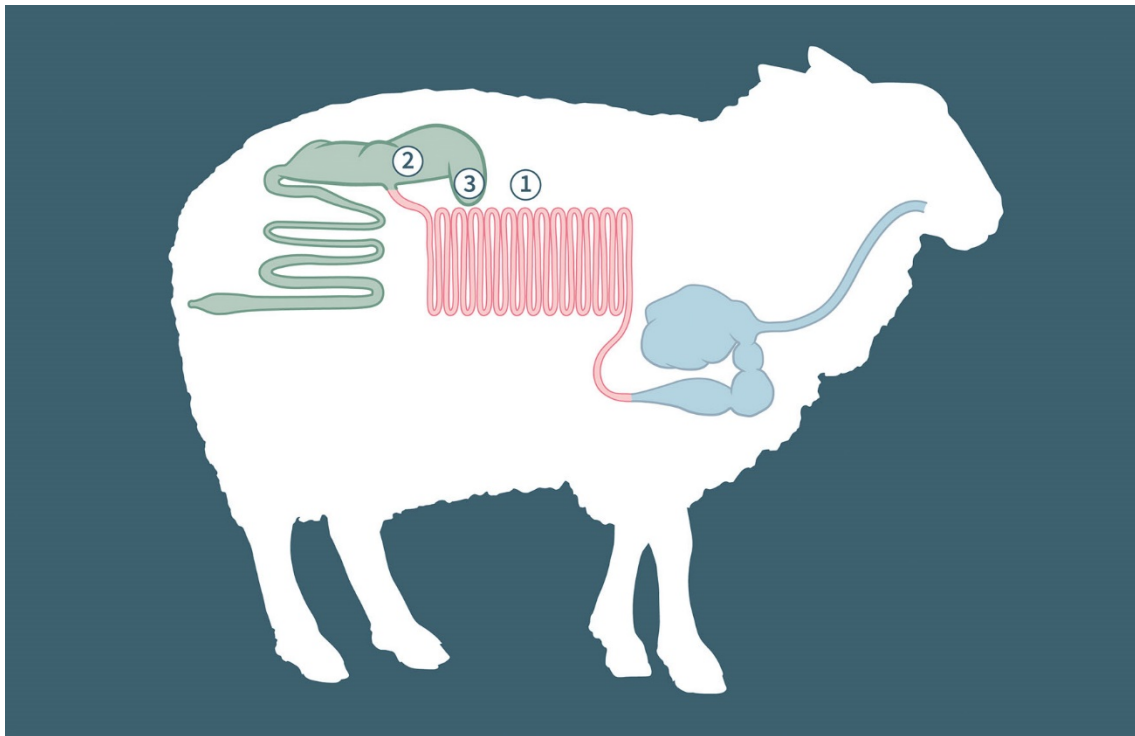

**Sheep casings**

**Table 3 and figure 3**

| Product name          | Anatomical reference  | Reference number |
|-----------------------|---|------------------|
| <b>Caprine origin</b> |   |                  |
| Goat casing           | Casings prepared from the duodenum, jejunum and ileum of goats  | <b>1</b>         |
| Bung end              | Casings prepared from the proximal part of the blind gut (caecum) of goats, connected to the large intestines | <b>2</b>         |
| Bung cap              | Casings prepared from the most distal part of the blind gut (caecum) of goats                                 | <b>3</b>         |

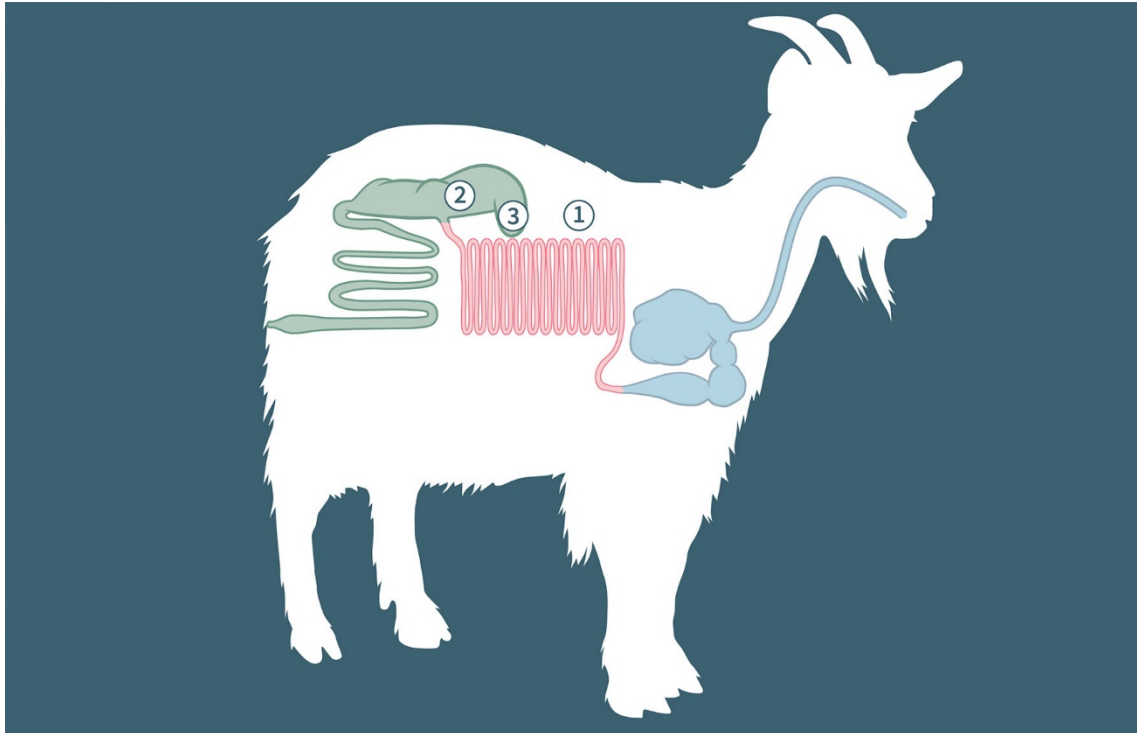

**Goat casings**

**Table 4 and figure 4**

| Product name         | Anatomical reference   | Reference number |
|----------------------|--|------------------|
| <b>Bovine origin</b> |  |                  |
| Beef rounds          | Casings prepared from the duodenum and jejunum of cattle   | <b>1</b>         |
| Bung end             | Casings prepared from the proximal part of the blind gut (caecum) of cattle, connected to the large intestines | <b>2</b>         |
| Bung cap             | Casings prepared from the most distal part of the blind gut (caecum) of cattle                                 | <b>3</b>         |
| Beef middles         | Casings prepared from the proximal part of the large intestines of cattle, starting at the blind gut           | <b>4</b>         |
| Beef fat end         | Casings prepared from the distal part of the large intestines of cattle  | <b>5</b>         |
| Bladders             | Casings prepared from the urinary bladder of cattle  | <b>6</b>         |

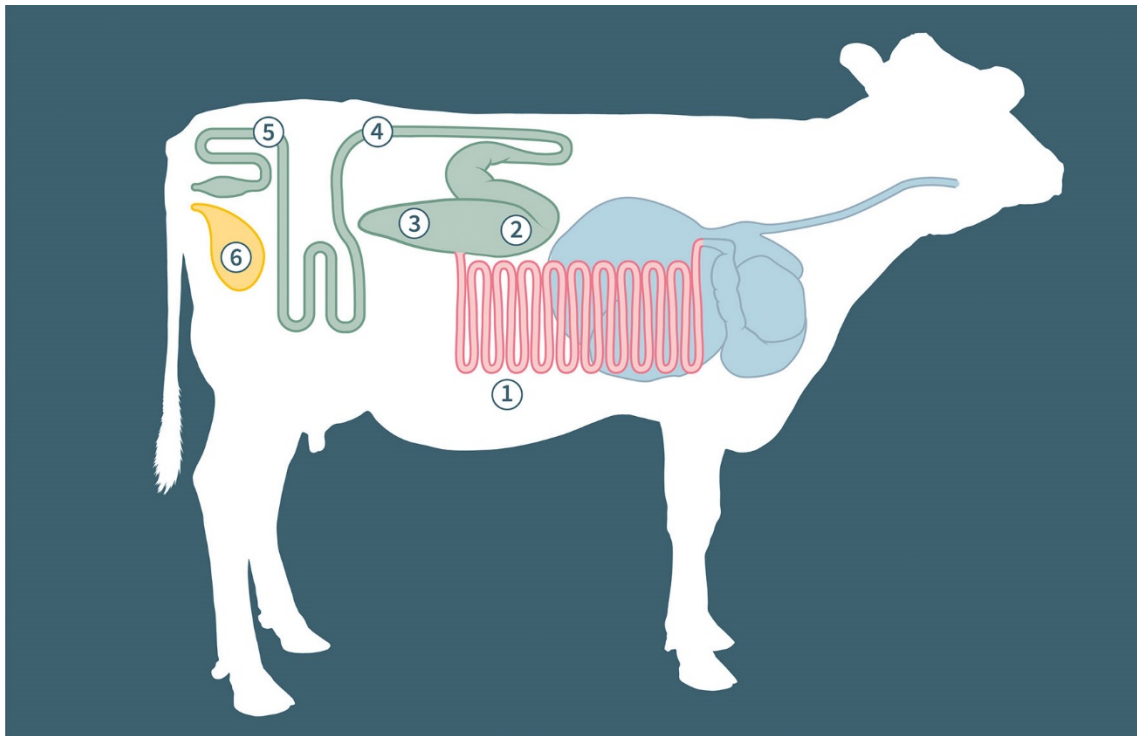

**Beef casings**

*Table 5 and figure 5*

| Product name          | Anatomical reference                                  | Reference number |
|-----------------------|---|------------------|
| <b>Equine origin</b>  |   |                  |
| Horse casing (rounds) | Casings prepared from the jejunum and ileum of horses | <b>1</b>         |

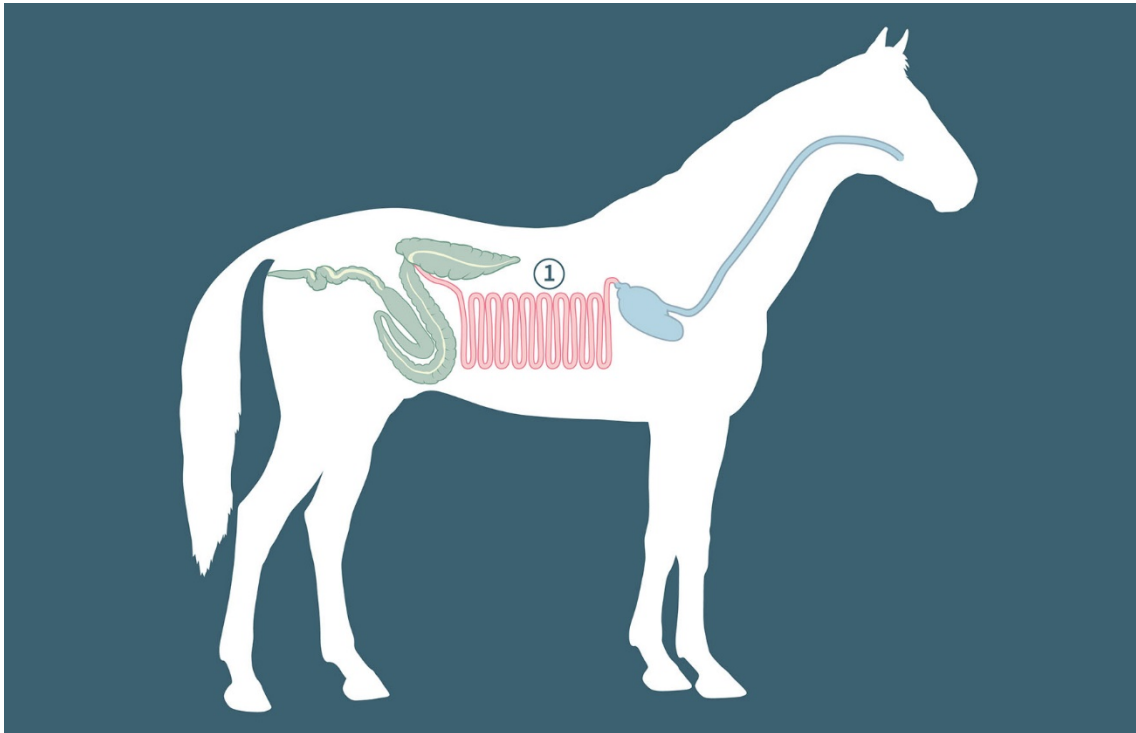

Horse casings

## ANNEX II Flowcharts production process natural casings

The following flow charts provide an indication of the different production steps (and their allocation to individual processing plants).

### Cleaning operations

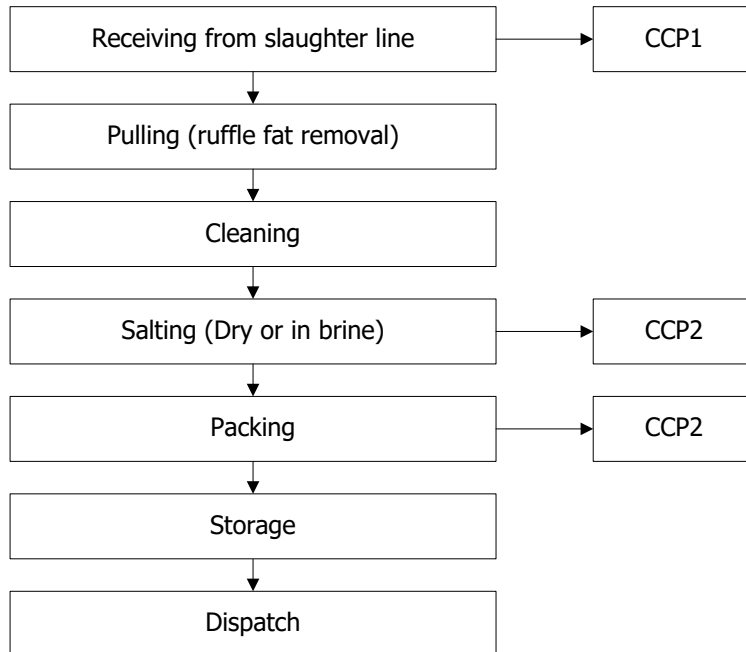

### Sorting operations

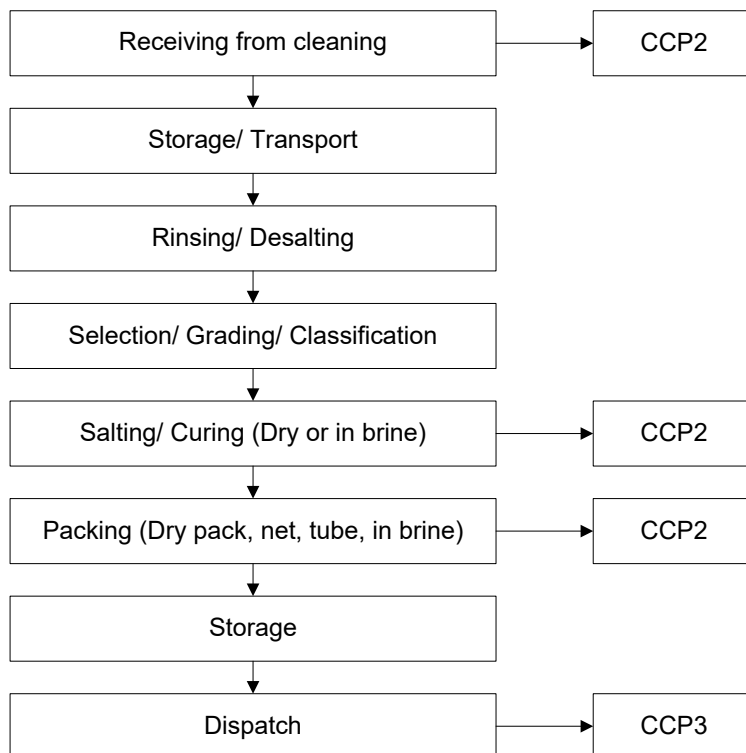



**Distribution centres**

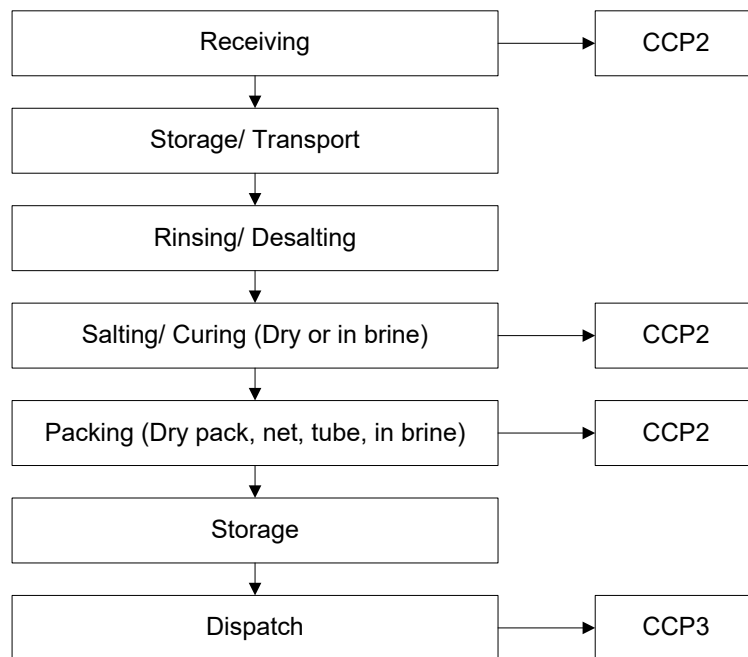

## ANNEX III Decision Tree to identify CCPs

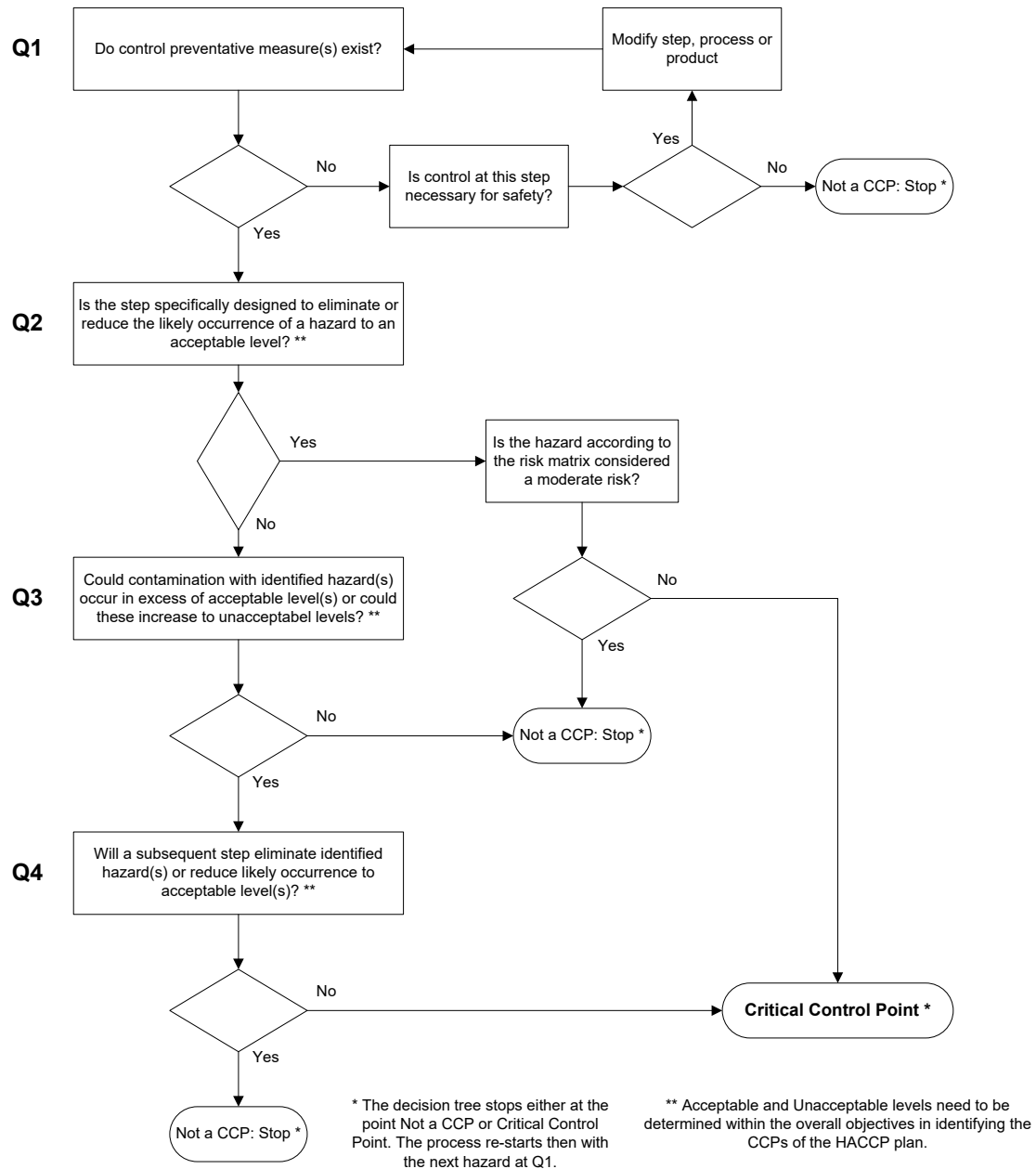

Decision Tree from the Annex of the "Guidelines for the Application of the Hazard Analysis Critical Control Point (HACCP) System, Recommended International Code of Practice, General Principles of Food Hygiene", Codex Alimentarius, rev.4-2003.

## Application of Decision Tree to determine CCPs

| <b>CCP 1 Removal of SRM</b> |  |
|-----------------------------|--|
| Q1                          | Do control preventative measure(s) exist(s)?   |
| A1                          | <b>YES</b> , The ileum of small ruminants and the last four meters of the small intestine, the caecum and the mesentery of the bovine intestinal tract are designated as SRM                 |
| Q2                          | Is the step specifically designed to eliminate or reduce the likely occurrence of a hazard to an acceptable level?   |
| A2                          | <b>YES</b> , the acceptable level is zero tolerance, no SRM in natural casings   |
| Q2-sub                      | Is the hazard according to the risk matrix considered a moderate risk?   |
| A2-sub                      | <b>NO → CRITICAL CONTROL POINT</b>   |
| <b>CCP 2 Salting</b>        |  |
| Q1                          | Q1 – Do control preventative measure(s) exist(s)?  |
| A1                          | <b>YES</b> , The application of salt (either as dry salt or as saturated brine) as preservative  |
| Q2                          | Is the step specifically designed to eliminate or reduce the likely occurrence of a hazard to an acceptable level?   |
| A2                          | <b>YES</b> , acceptable levels of bacteria present on natural casings have been defined  |
| Q2-sub                      | Is the hazard according to the risk matrix considered a moderate risk?   |
| A2-sub                      | <b>NO → CRITICAL CONTROL POINT</b>   |
| <b>CCP 3 Salting period</b> |  |
| Q1                          | Do control preventative measure(s) exist(s)?   |
| A1                          | <b>YES</b> , together with the use of salt as preservative, the minimum period of exposure to sufficient quantities of salt (either as dry salt or as saturated brine) is defined as 30 days |
| Q2                          | Is the step specifically designed to eliminate or reduce the likely occurrence of a hazard to an acceptable level?   |
| A2                          | <b>YES</b> , acceptable levels of bacteria present on natural casings after 30 days in salt have been defined  |
| Q2-sub                      | Is the hazard according to the risk matrix considered a moderate risk?   |
| A2-sub                      | <b>NO → CRITICAL CONTROL POINT</b>   |

## ANNEX IV EU translations of natural sausage casings

| Language          | EU health certificate (2003/779/EC) | Translations treated intestines | National term                                   |
|-------------------|-------------------------------------|---------------------------------|---|
| <b>Bulgarian</b>  | животински черва                    | Естествена обвивка              | Осолени черва                                   |
| <b>Croatian</b>   |                                     | ovitak                          |   |
| <b>Czech</b>      | zvířecích střev                     | Střívka                         |   |
| <b>Danish</b>     | Dyretarme                           | Dyretarme                       | Naturtarme                                      |
| <b>Dutch</b>      | Darmen van dieren                   | Behandelde darmen               | Natuurdarmen                                    |
| <b>English</b>    | Animal casings                      | Treated intestines              | Natural casings                                 |
| <b>Estonian</b>   | Loomasoolte kohta                   | Töödeldud põied                 | Naturaalsool                                    |
| <b>Finnish</b>    | Eläinten suolet                     | Käsitellyt suolet               | Luonnonsuolet                                   |
| <b>French</b>     | Boyaux d'animaux                    | Boyaux traités                  | Boyaux naturels                                 |
| <b>German</b>     | Tierdärme                           | Bearbeitete Därme               | Naturdärme                                      |
| <b>Greek</b>      | ζωικών εντέρων                      | Επεξεργασμένα έντερα            | Επεξεργασμένα έντερα                            |
| <b>Hungarian</b>  | Tisztított állati                   | Kezelt hólyag                   | Természetes bél                                 |
| <b>Italian</b>    | Involucri di origine animale        | Intestini trattati              | Budello naturale                                |
| <b>Latvian</b>    | Dzīvnieku zarnas                    | Apstrādāti pūšji                |   |
| <b>Lithuanian</b> | Gyvūnų žarnos                       | Apdoroti pūslės                 |   |
| <b>Maltese</b>    |                                     |                                 |   |
| <b>Polish</b>     | Oślonek zwierzęcych                 | Obrobione pecherze              | Jelita naturalne                                |
| <b>Portuguese</b> | Tripas de animais                   | Intestinos tratados             | Tripa natural                                   |
| <b>Romanian</b>   | Intestine de animale                | Intestine tratate               | Membrane naturale (mate de porc / mate de oaie) |
| <b>Slovak</b>     | Zvieracích čriev                    | Ošetrované mechúre              |   |
| <b>Slovenian</b>  | Črevá zvierat                       | Črevá                           |   |
| <b>Spanish</b>    | Tripas de animales                  | Intestinos tratados             | Tripa natural                                   |
| <b>Swedish</b>    | Djurtarm                            | Behandlade tarmar               | Naturtarm                                       |

## Official translations of “intestines” and casings” in Articles 6-7 of Commission Implementing Regulation (EU) [ SANTE/10280/2018]

As provided by the EU COM Services

### Casings

Please use the wordings in column 2 of the Table below

| Language          | Translation of “casings” proposed | Remark with regard to Decision 2003/779/EC |
|-------------------|-----------------------------------|--|
| <b>Bulgarian</b>  | Естествена обвивка                | different                                  |
| <b>Croatian</b>   | ovitak                            | different                                  |
| <b>Czech</b>      | střívka                           | different                                  |
| <b>Danish</b>     | dyretarme                         | identical                                  |
| <b>Dutch</b>      | casings                           | different                                  |
| <b>Estonian</b>   | vorstikest                        | different                                  |
| <b>Finnish</b>    | eläinten suolet                   | identical                                  |
| <b>French</b>     | boyaux                            | identical                                  |
| <b>German</b>     | Tierdarmhüllen                    | different                                  |
| <b>Greek</b>      | υλικά ενθήκευσης αλλαντικών       | different                                  |
| <b>Hungarian</b>  | tisztított állati belek           | identical                                  |
| <b>Italian</b>    | budello                           | different                                  |
| <b>Latvian</b>    | apvalkiem                         | different                                  |
| <b>Lithuanian</b> | apvalkalai                        | different                                  |
| <b>Maltese</b>    | budellat                          | different                                  |
| <b>Polish</b>     | osłonki                           | identical                                  |
| <b>Portuguese</b> | tripas de animais                 | identical                                  |
| <b>Romanian</b>   | membrane de intestine             | different                                  |
| <b>Slovak</b>     | Zvieracích čriev                  | identical                                  |
| <b>Slovenian</b>  | čreva                             | identical                                  |
| <b>Spanish</b>    | tripas de animales                | identical                                  |
| <b>Swedish</b>    | fjälster                          | different                                  |

## **Intestines**

Please use the same wordings as in Point 7.9 of Annex I to Regulation (EC) No 853/2004, except in the FR version where "treated intestines" should be translated as "intestins traités". A corrigendum to R 853/2004 has been launched to align.

A corrigendum to for Decision 2003/779/EC will not be launched. The decision is scheduled to be replaced by a delegated Regulation from April 2021.

Some contact points made suggestions for the longer part of the title of Article 2:

- Estonian proposal for treated stomachs, bladders and intestines other than casings: "töödeldud maod, põied ja sooled, välja arvatud vorstikestad"
- Latvian proposal for "treated stomachs, bladders and intestines other than casings": "un apstrādāti kuņģi, pūšļi un apvalkiem neizmantojamās zarnas"
- Slovenian proposal to translate "intestines others than casings": "in črevesij razen črev"

## ANNEX V Applicable EU legislation

Updated June 2019

### Introduction

An overview of the different EU legislation applicable to the production and (international) trade in natural sausage casings has been prepared and presented in the table below. Please note that this overview can be modified without prior notification. Therefore, please check the ENSCA website ([www.ensca.eu](http://www.ensca.eu)) for the latest version.

- Each reference is linked to the actual document in English on the EUR-Lex website (<http://eur-lex.europa.eu/en/index.htm>).
- If the document is required in a different language go to the [search engine on the EUR-Lex website](#), choose natural number or consolidated text (consleg) and enter the year and number of the document. The language of the search result can be changed in the header of the page.
- Where possible the "Consolidated Text" version (**consleg**) will be used, as this text will be the original Directive / Regulation or Decision with the latest amendment included in the document.
- If a consleg version has been changed recently, this is indicated by → amended.
- Various legal texts have actual reference to natural casings, using either the term "treated intestines" or "animal casings". These texts are included in the overview (in *Italics*). If such a reference text does not exist and the subject is too general, specific keywords or comments are listed.

| Hygiene legislation / Food Safety Law                              |   |   |
|--|---|---|
| Reference + link   | Subject   | Specific text on casings, keywords or comment   |
| <a href="#">Regulation (EC) No 852/2004</a><br>(consleg)           | on the hygiene of foodstuffs  | Article 5:<br>HACCP principles<br><br>Article 7:<br>Guide to Good Practice  |
| <a href="#">Regulation (EC) No 853/2004</a><br>(consleg) → Amended | laying down specific hygiene rules for food of animal origin  | Annex I / point 7.9:<br><i>Treated stomachs, bladders and intestines' means stomachs, bladders and intestines that have been submitted to a treatment such as salting, heating or drying after they have been obtained and after cleaning.</i><br><br>Annex III / section XIII:<br><i>Food business operators treating stomachs, bladders and intestines must ensure compliance with the following requirements.</i><br><i>1. Animal intestines, bladders and stomachs may be placed on the market only if:</i><br><i>(a) they derive from animals which have been slaughtered in a slaughterhouse, and which have been found fit for human consumption following ante-mortem and post-mortem inspection;</i><br><i>(b) they are salted, heated or dried;</i><br><i>and</i><br><i>(c) after the treatment referred to in (b), effective measures are taken to prevent re-contamination.</i><br><i>2. Treated stomachs, bladders and intestines that cannot be kept at ambient temperature must be stored chilled using facilities intended for that purpose until their dispatch. In particular, products that are not salted or dried must be kept at a temperature of not more than 3 °C.</i> |
| <a href="#">Regulation (EC) No 854/2004</a><br>(consleg) → Amended | laying down specific rules for the organisation of official controls on products of animal origin intended for human consumption  | Competent authorities   |
| <a href="#">Directive 2004/41/EC</a>                               | repealing certain directives concerning food hygiene and health conditions for the production and placing on the market of certain products of animal origin intended for human consumption | Transitional document, implementing new hygiene regulation  |
| <a href="#">Regulation (EC) No 178/2002</a><br>(consleg) → Amended | laying down the general principles and requirements of food law, establishing the European Food Safety Authority and laying down procedures in matters of food safety                       | Food business operator; traceability  |



|  |   |  |
|--|---|--|
| <a href="#">Regulation (EC) No 882/2004</a><br>(consleg) → Amended | on official controls performed to ensure the verification of compliance with feed and food law, animal health and animal welfare rules  | Controls by the competent authorities of the Implementation of HACCP principles  |
| <a href="#">Regulation (EC) No 931/2011</a>                        | on the traceability requirements set by Regulation (EC) No 178/2002 of the European Parliament and of the Council for food of animal origin   | Traceability requirements  |
| <a href="#">Regulation (EC) No 1169/2011</a><br>(consleg)          | on the provision of food information to consumers   | Annex VI:<br>PART C — SPECIFIC REQUIREMENTS CONCERNING THE DESIGNATION OF SAUSAGE CASINGS<br><i>If a sausage casing is not edible, this must be indicated.</i><br><br>Annex VII:<br>PART A – SPECIFIC PROVISIONS CONCERNING THE INDICATION OF INGREDIENTS BY DESCENDING ORDER OF WEIGHT<br><i>Point 7:</i><br><i>Ingredients, which are similar or mutually substitutable, likely to be used in the manufacture or preparation of a food without altering its composition, its nature or its perceived value, and in so far as they constitute less than 2 % of the finished product: May be referred to in the list of ingredients by means of the statement 'contains ... and/ or ...'; where at least one of no more than two ingredients is present in the finished product.</i>   |
| <b>Health certificates</b>   |   |  |
| <b>Reference + link</b>  | <b>Subject</b>  | <b>Specific text on casings, keywords or comment</b>   |
| <a href="#">Commission Decision 2003/779/EC</a><br>(consleg)       | laying down animal health requirements and the veterinary certification for the <b>import of animal casings</b> from third countries<br><br><b>This certificate is solely intended for the import of natural sausage casings, as defined in paragraph 2.1 of the ENSCA cGGP</b> | Article 1:<br><i>Member States shall authorise the importation of animal casings from any third country accompanied by a health certificate as laid down in Annex I A, which shall consist of one sheet and shall be completed in at least one official language of the Member State carrying out the import control.</i><br><br>Article 1a:<br><i>Member States shall ensure that consignments of animal casing for human consumption introduced into the territory of the Community and which are destined for a third country either by transit immediately or after storage in accordance with Articles 12 (4) or 13 of Directive 97/ 78/EC, and not intended for importation into the EC shall comply with the following requirements:</i><br><i>(a) they shall meet the specific animal health conditions set out in the model animal health certificate drawn up under Annex I A;</i><br><i>(b) they shall be accompanied by an animal health certificate established in accordance with the model laid down in Annex I B, signed by an official veterinarian of the competent veterinary services of the third country concerned;</i><br><i>(c) they are certified as acceptable for transit or storage (as appropriate) on the Common Veterinary Entry Document by the Official Veterinarian of the Border Inspection Post of introduction.</i> |

|   |   |   |
|---|---|---|
| <a href="#">Commission Decision 2007/240/EC</a>                               | laying down new veterinary certificates for importing live animals, semen, embryos, ova and products of animal origin   | For standardisation and for effective computer processing (known as TRACES), the European Commission has published on April 21 <sup>st</sup> , 2007 this decision with standard models for veterinary certificates which may be used by third countries.  |
| <a href="#">Commission Decision 2007/777/EC</a><br>(consleg)                  | laying down the animal and public health conditions and model certificates for imports of certain meat products and treated stomachs, bladders and intestines for human consumption from third countries  | Article 1 point (b): <i>treated stomachs, bladders and intestines, as defined in point 7.9 of that Annex (Annex I Regulation (EC) No 853/2004), which have undergone one of the treatments laid down in Annex II part 4 to this Decision (2004/777/EC).</i><br>–interpretation–: in the referred-to Annex II part 4, the treatment of salting for 30 days is not included. Therefore, this Decision, its certificates and requirements are <b>NOT</b> applicable to natural casings.  |
| <a href="#">Commission Regulation (EC) No 206/2009</a><br>(consleg) → Amended | on the introduction into the Community of personal consignments of products of animal origin  | Article 2 point (d) –interpretation–: natural casings can be regarded a personal consignment and their combined quantity does not exceed the weight limit of 2 kg. No health certificate is therefore required on entry into the EU.  |
| <a href="#">Commission Regulation (EC) No 206/2010</a><br>(consleg)           | laying down lists of third countries, territories or parts thereof authorised for the introduction into the European Union of certain animals and fresh meat and the veterinary certification requirements<br><br><b>This certificate is solely intended for the import of frozen cleaned preserved intestines or frozen, untreated stomachs or bladders, not for casings</b> | Cleaned preserved intestines that have been manure stripped but not scraped and salted or dried are considered as fresh meat and therefore a fresh meat certificate is applicable.<br>On this new health certificate it is now possible to enter the HS code 050400 for cleaned preserved intestines. See pages 108 to 114 for the respective health certificates.<br><br>The following “description of commodity” (box I.18) can be used:<br><i>Cleaned preserved intestines of bovine, ovine or porcine origin, intended for processing of natural sausage casings for human consumption.</i> |
| <b>Third country establishments list</b>                                      |   |   |
| <b>Reference + link</b>   | <b>Subject</b>  | <b>Specific text on casings, keywords or comment</b>  |
| <a href="#">Commission Implementing Decision 2014/160/EU</a><br>→New          | Commission Implementing Decision of 20 March 2014 repealing lists of third country establishments from which Member States authorise imports of certain products of animal origin adopted on the basis of Council Decision 95/408/EC  | <a href="#">Third country establishments (list per section)</a>   |

| Animal health requirements  |  |   |
|---|--|---|
| Reference + link  | Subject  | Specific text on casings, keywords or comment   |
| <a href="#">Regulation (EC) No 999/2001</a><br>(consleg) →Amended | laying down rules for the prevention, control and eradication of certain transmissible spongiform encephalopathies | <p>Annex V:</p> <p><b>1. Definition of specified risk material</b><br/> <i>The following tissues shall be designated as specified risk material if they come from animals whose origin is in a Member State or third country or of one of their region with a controlled or undetermined BSE risk:</i></p> <p>(a) as regards bovine animals:</p> <p>(i) the skull excluding the mandible and including the brain and eyes, and the spinal cord of animals aged over 12 months;</p> <p>(ii) the vertebral column excluding the vertebrae of the tail, the spinous and transverse processes of the cervical, thoracic and lumbar vertebrae and the median sacral crest and wings of the sacrum, but including the dorsal root ganglia, of animals aged over 30 months; and</p> <p>(iii) the tonsils, <u>the last four meters of the small intestine, the caecum</u> and the mesentery of animals of all ages.</p> <p><b>2. Specific requirements for Member States with negligible risk status</b><br/> <i>Tissues listed in point 1.(a)(i) and 1.(b), which are derived from animals whose origin is in Member States with a negligible BSE risk, shall be considered as specified risk material.</i></p> <p>Annex IX, Chapter C, Section B:</p> <p><b>Imports from a country or a region with a negligible BSE risk</b><br/> <i>Imports of products of bovine, ovine and caprine animal origin referred to in Section A from a country or a region with a negligible BSE risk shall be subject to the presentation of an animal health certificate attesting that:</i></p> <p>(a) the country or region is classified in accordance with Decision 2007/453/EC as a country or region posing a negligible BSE risk;</p> <p>(b) the animals from which the products of bovine, ovine and caprine animal origin were derived passed ante-mortem and post-mortem inspections;</p> <p>(c) the products of bovine, ovine and caprine animal origin do not contain and are not derived from specified risk material as defined in point 1 of Annex V to this Regulation;</p> <p>(d) if the animals, from which the products of bovine animal origin were derived, originate from a country or region classified in accordance with Decision 2007/453/EC as a country or region posing a controlled or an undetermined BSE risk, by way of derogation from point (c) of this Section, carcasses, half carcasses or half carcasses cut into no more than three wholesale cuts, and quarters containing no specified risk material other than the vertebral column, including dorsal root ganglia, may be imported. In the case of such imports, the carcasses or wholesale cuts of carcasses of bovine animals containing a vertebral column which is defined as specified risk material in accordance with point 1 of Annex V to this Regulation shall be identified by a clearly visible red stripe on the label referred to in Article 13 or 15 of Regulation (EC) No 1760/2000. Furthermore, specific information on the number of bovine carcasses or wholesale cuts of carcasses, from which the removal of the vertebral column is required, shall be added to the Common Veterinary Entry Document (CVED) referred to in Article 2(1) of Regulation (EC) No 136/2004;</p> <p>(e) the products of bovine, ovine and caprine animal origin do not contain and are not derived from mechanically separated meat obtained from bones of bovine, ovine or caprine animals, except if the animals, from which the products</p> |

|  |   |
|--|---|
|  | <p><i>of bovine, ovine and caprine animal origin are derived, were born, continuously reared and slaughtered in a country or region classified in accordance with Decision 2007/453/EC as a country or region posing a negligible BSE risk in which there has been no BSE indigenous cases;</i></p> <p><i>(f) the animals from which the products of bovine, ovine and caprine animal origin were derived have not been slaughtered after stunning by means of gas injected into the cranial cavity or killed by the same method or slaughtered by laceration after stunning of central nervous tissue by means of an elongated rod-shaped instrument introduced into the cranial cavity, except if the animals from which the products of bovine, ovine and caprine animal origin are derived, were born, continuously reared and slaughtered in a country or region classified in accordance with Decision 2007/453/EC as a country or region posing a negligible BSE risk;</i></p> <p><i>(g) if the animals, from which the products of bovine, ovine and caprine animal origin were derived, originate from a country or region classified in accordance with Decision 2007/453/EC as a country or region posing an undetermined BSE risk, the animals have not been fed with meat-and-bone meal or greaves, as defined in the OIE Terrestrial Animal Health Code;</i></p> <p><i>(h) if the animals, from which the products of bovine, ovine and caprine animal origin were derived, originate from a country or region classified in accordance with Decision 2007/453/EC as a country or region posing an undetermined BSE risk, the products were produced and handled in a manner which ensures that they did not contain and were not contaminated with nervous and lymphatic tissues exposed during the deboning process.</i></p> <p>Annex IX, Chapter C, Section C:<br/> <b>Imports from a country or a region with a controlled BSE risk</b><br/> 1. Imports of products of bovine, ovine and caprine animal origin referred to in Section A from a country or a region with a controlled BSE risk shall be subject to the presentation of an animal health certificate attesting that:<br/> <i>(a) the country or region is classified in accordance with Decision 2007/453/EC as a country or region posing a controlled BSE risk;</i><br/> <i>(b) the animals from which the products of bovine, ovine and caprine animal origin were derived passed ante-mortem and post-mortem inspections;</i><br/> <i>(c) the animals from which the products of bovine, ovine and caprine animal origin destined for export were derived have not been killed, after stunning, by laceration of central nervous tissue by means of an elongated rod-shaped instrument introduced into the cranial cavity, or by means of gas injected into the cranial cavity;</i><br/> <i>(d) the products of bovine, ovine and caprine animal origin do not contain and are not derived from specified risk material as defined in point 1 of Annex V to this Regulation, or mechanically separated meat obtained from bones of bovine, ovine or caprine animals.</i><br/> 5. In the case of intestines originally sourced from a country or a region with a negligible BSE risk, imports of treated intestines shall be subject to the presentation of an animal health certificate attesting that:<br/> <i>(a) the country or region is classified in accordance with Decision 2007/453/EC as a country or region posing a controlled BSE risk;</i><br/> <i>(b) the animals from which the products of bovine, ovine and caprine animal origin were derived were born, continuously reared and slaughtered in the country or region with a negligible BSE risk and passed ante-mortem and post-mortem inspections;</i><br/> <i>(c) if the intestines are sourced from a country or region where there have been BSE indigenous cases:</i><br/> <i>(i) the animals were born after the date from which the ban on the feeding of ruminants with meat-and-bone meal and greaves derived from ruminants had been enforced; or</i></p> |
|--|---|

|   |  |  |
|---|--|--|
|   |  | <p>(ii) the products of bovine, ovine and caprine animal origin do not contain and are not derived from specified risk material as defined in point 1 of Annex V to this Regulation.</p> <p>Annex IX, Chapter C, Section D:<br/> <b>Imports from a country or a region with an undetermined BSE risk</b><br/> 1. Imports of products of bovine, ovine and caprine animal origin referred to in Section A from a country or a region with an undetermined BSE risk shall be subject to the presentation of an animal health certificate attesting that:<br/> (a) the animals from which the products of bovine, ovine and caprine animal origin were derived have not been fed meat-and-bone meal or greaves derived from ruminants, as defined in the OIE Terrestrial Animal Health Code, and passed ante mortem and post mortem inspections;<br/> (b) the animals from which the products of bovine, ovine and caprine animal origin were derived have not been killed, after stunning, by laceration of central nervous tissue by means of an elongated rod-shaped instrument introduced into the cranial cavity, or by means of gas injected into the cranial cavity;<br/> (c) the products of bovine, ovine and caprine animal origin do not contain and are not derived from:<br/> (i) specified risk material as defined in point 1 of Annex V to this Regulation;<br/> (ii) nervous and lymphatic tissues exposed during the deboning process;<br/> (iii) mechanically separated meat obtained from bones of bovine, ovine or caprine animals.</p> <p>5. In the case of intestines originally sourced from a country or a region with a negligible BSE risk, imports of treated intestines shall be subject to the presentation of an animal health certificate attesting that:<br/> (a) the country or region is classified in accordance with Decision 2007/453/EC as a country or region posing an undetermined BSE risk;<br/> (b) the animals from which the products of bovine, ovine and caprine animal origin were derived were born, continuously reared and slaughtered in the country or region with a negligible BSE risk and passed ante-mortem and post-mortem inspections;<br/> (c) if the intestines are sourced from a country or region where there have been BSE indigenous cases:<br/> (i) the animals were born after the date from which the ban on the feeding of ruminants with meat-and-bone meal and greaves derived from ruminants had been enforced; or<br/> (ii) the products of bovine, ovine and caprine animal origin do not contain and are not derived from specified risk material as defined in point 1 of Annex V to this Regulation.</p> |
| <a href="#">Commission Decision 2007/453/EC</a><br>(consleg)        | establishing the BSE status of Member states or third countries or regions thereof according to their BSE risk | Contains an overview of all countries with a BSE negligible risk status  |
| <a href="#">Council Directive 2003/85/EC</a><br>(consleg) → Amended | on Community measures for the control of foot-and-mouth-disease  | Annex VII, part A, point 9:<br><i>Animal casings which in accordance with Chapter 2 of Annex I to Directive 92/118/EEC have been cleaned, scraped and either salted with sodium-chloride for 30 days or bleached or dried after scraping and were protected from re-contamination after treatment.</i>   |
| <a href="#">Directive 2003/99/EC</a><br>(consleg)                   | on the monitoring of zoonoses and zoonotic agents, amending Council  |  |

|  | Decision 90/424/EEC and repealing Council Directive 92/117/EEC   |  |
|--|--|--|
| <b>Veterinary checks</b>                                   |  |  |
| Reference + link   | Subject  | Specific text on casings, keywords or comment  |
| <a href="#">Council Directive 92/118/EEC</a><br>(consleg)  | laying down animal health and public health requirements governing trade in and imports into the Community of products not subject to the said requirements laid down in specific Community rules referred to in Annex A (I) to Directive 89/662/EEC and, as regards pathogens, to Directive 90/425/EEC. | Annex I, Chapter 2:<br><b>Animal casings intended for human consumption</b><br><i>A. Trade</i><br><i>Trade in animal casings is subject to production of a document specifying the plant of origin which must be:</i><br><i>— where the casings are salted or dried at the point of origin and where salted or dried casings are subsequently handled for other purposes, a plant approved by the competent authority,</i><br><i>— in other cases, a plant approved in accordance with Directive 64/433/EEC, provided the casings are transported in such a way as to avoid contamination.</i><br><br><i>B. Imports from third countries</i><br><i>Imports of animal casings from any third country are subject to production of the certificate referred to in Article 10 (2) (c), issued and signed by an official veterinarian of the exporting third country, stating that:</i><br><i>(i) the casings come from plants approved by the competent authority of the exporting country;</i><br><i>(ii) the casings have been cleaned, scraped and then either salted or bleached (or as an alternative to salting or bleaching, that they have been dried after scraping);</i><br><i>(iii) after the treatment in (ii), effective steps were taken to prevent the recontamination of the casings.</i> |
| <a href="#">Commission Decision 94/360/EC</a><br>(consleg) | on the reduced frequency of physical checks of consignments of certain products to be implemented from third countries, under Council Directive 90/675/EEC   | Annex 1:<br><i>Groups of products and the frequencies of physical checks which must be carried out by each member state on consignments of products imported from third country establishments referred to in article 1</i><br><br><i>Category I</i><br><i>5. Animal casings → 20% physical checks</i>   |
| <a href="#">Council Directive 97/78/EC</a><br>(consleg)    | laying down the principles governing the organisation of veterinary checks on products entering the Community from third countries   |  |
| <a href="#">Council Directive 2002/99/EC</a><br>(consleg)  | laying down the animal health rules governing the production, processing, distribution and introduction of products of animal origin for human consumption   |  |

|  |  |  |
|--|--|--|
| <a href="#">Commission Decision 2009/821/EC</a><br>(consleg) → Amended | drawing up a list of approved border inspection posts, laying down certain rules on the inspections carried out by Commission veterinary experts and laying down the veterinary units in Traces  |  |
| <a href="#">Commission Decision 2007/275/EC</a><br>(consleg)           | concerning lists of animals and products to be subject to controls at border inspection posts under Council Directives 91/496/EEC and 97/78/EC   | Article 2, definitions:<br>(c) processed products: the processed products listed under point 7 of Annex I to Regulation (EC) No 853/2004;<br><br>Article 3:<br>1. The animals and products listed in Annex I to this Decision shall be subjected to veterinary checks at border inspection posts in accordance with Directives 91/496/EEC and 97/78/EC.<br><br>Annex I, Chapter 5: Products of animal origin, not elsewhere specified or included → 050400 |
| <b>Food additives</b>  |  |  |
| <b>Reference + link</b>  | <b>Subject</b>   | <b>Specific text on casings, keywords or comment</b>   |
| <a href="#">Commission Regulation (EC) No 1069/2013</a>                | Amending Annex II to Regulation (EC) No 1333/2008 of the European Parliament and of the Council as regards the use of sodium phosphates (E 339) in natural casings for sausages  | Food category 08.3.3 'Casings and coatings and decoration for meat'<br><br>12600 mg/kg casing, expressed as P <sub>2</sub> O <sub>5</sub><br><br>Carry-over into the final product shall not exceed 250 mg/kg  |
| <a href="#">Regulation (EC) No 1333/2008</a><br>(consleg) → Amended    | on food additives  |  |
| <b>Residues</b>  |  |  |
| <b>Reference + link</b>  | <b>Subject</b>   | <b>Specific text on casings, keywords or comment</b>   |
| <a href="#">Regulation (EC) No 470/2009</a>                            | laying down Community procedures for the establishment of residue limits of pharmacologically active substances in foodstuffs of animal origin, <b>repealing Council Regulation (EEC) No 2377/90</b> and amending Directive 2001/82/EC of the European Parliament and of the Council and Regulation (EC) No 726/2004 of the European Parliament and of the Council |  |

|   |   |   |
|---|---|---|
| <a href="#">Commission Regulation (EC) No 37/2010</a><br>(consleg) →Amended | on pharmacologically active substances and their classification regarding maximum residue limits in foodstuffs of animal origin                                     | Table 2, Prohibited substances: <ul style="list-style-type: none"> <li>• Chloramphenicol, MRL cannot be established</li> <li>• Nitrofurans, MRL cannot be established</li> </ul>  |
| <a href="#">Commission Regulation (EC) No 124/2009</a><br>(consleg)         | setting maximum levels for the presence of coccidiostats or histomonostats in food resulting from the unavoidable carry-over of these substances in non-target feed |   |
| <a href="#">Council Directive 96/23/EC</a><br>(consleg)                     | on measures to monitor certain substances and residues thereof in live animals and animal products  | Chapter VI:<br>Imports from third countries, article 29   |
| <a href="#">Commission Decision 2011/163/EC</a><br>(consleg) →Amended       | on the approval of plans submitted by third countries in accordance with Article 29 of Council Directive 96/23/EC   |   |
| <a href="#">Commission Decision 2002/657/EC</a><br>(consleg)                | Implementing Council Directive 96/23/EC concerning the performance of analytical methods and the interpretation of results  | With this decision MRPLs are set for chloramphenicol of 0,3 µg/kg and for nitrofurans and their metabolites of 1 µg/kg  |
| <a href="#">Commission Decision 2005/34/EC</a>                              | laying down harmonised standards for the testing for certain residues in products of animal origin imported from third countries                                    | Article 3:<br><b>Action in case of confirmed presence of a prohibited or non-authorized substance</b><br><i>1. Where results of analytical tests are at or above the MRPLs laid down in Decision 2002/657/EC, the consignment concerned shall be considered non-compliant with Community legislation.</i> |
| <a href="#">Regulation (EC) No 396/2005</a><br>(consleg) →Amended           | on maximum residue levels of pesticides in or on food and feed of plant and animal origin and amending Council Directive 91/414/EEC                                 |   |
| <a href="#">Regulation (EC) No 1935/2004</a><br>(consleg)                   | on materials and articles intended to come into contact with food and repealing Directives 80/590/EEC and 89/109/EEC  |   |
| <a href="#">Commission Regulation (EC) No 10/2011</a><br>(consleg) →Amended | on plastic materials and articles intended to come into contact with food   |   |
|   |   |   |



| Requirements dealing with specific third countries              |  |  |
|---|--|--|
| Reference + link  | Subject  | Specific text on casings, keywords or comment  |
| <a href="#">Commission Decision 2002/994/EC</a><br>(consleg)    | concerning certain protective measures with regard to products of animal origin imported from China  | Article 3:<br><i>Member States shall authorise imports of consignments of products listed in Part II of the Annex accompanied by a declaration of the Chinese competent authority stating that each consignment has been subjected before dispatch to a chemical test in order to ensure that the products concerned do not present a danger to human health. This test must be carried out, in particular, with a view to detecting the presence of chloramphenicol and nitrofurans and its metabolites. The results of the analytical checks have to be included.</i><br>Annex, Part II:<br><i>List of products of animal origin intended for human consumption or animal feed use authorised to be imported into the Community, subject to be accompanied of the attestation provided by Article 3:</i><br><br><i>- casings</i> |
| <a href="#">Commission Implementing Decision (EU) 2015/1901</a> | Laying down certification rules and a model health certificate for importation into the Union of live animals and animal products from New Zealand and repealing Decision 2003/56/EC   |  |
| <a href="#">Commission Implementing Decision (EU) 2015/1084</a> | approving on behalf of the European Union certain amendments to Annexes II, V, VII and VIII to the Agreement between the European Community and New Zealand on sanitary measures applicable to trade in live animals and animal products | Section 3 Other products for human consumption<br><br>7. Products intended for human consumption<br><br>7.A. Animal casings  |
| Animal By-Products  |  |  |
| Reference + link  | Subject  | Specific text on casings, keywords or comment  |
| <a href="#">Regulation (EC) No 1069/2009</a><br>(consleg)       | laying down health rules as regards animal by-products and derived products not intended for human consumption and repealing Regulation (EC) No 1774/2002  | Article 17:<br><b>Research and other specific purposes</b><br><i>1. The competent authority may, by way of derogation from Articles 12, 13 and 14, authorise the use of animal by-products and derived products for exhibitions, <b>artistic activities</b> (e.g. strings), and for diagnostic, educational or research purposes under conditions which ensure the control of risks to public and animal health.</i>   |

|  |  |  |
|--|--|--|
| <a href="#">Commission Regulation (EU) No 142/2011</a><br>(consleg) →Amended | implementing Regulation (EC) No 1069/2009 of the European Parliament and of the Council laying down health rules as regards animal by-products and derived products not intended for human consumption and implementing Council Directive 97/78/EC as regards certain samples and items exempt from veterinary checks at the border under that Directive | Article 26:<br><b>Placing on the market, including importation, and export of certain Category 1 materials</b><br><i>The competent authority may authorise the placing on the market, including the importation, and the export of hides and skins derived from animals which have been submitted to an illegal treatment as defined in Article 1(2)(d) of Directive 96/22/EC or in Article 2(b) of Directive 96/23/EC, and of <b>ruminant intestines</b> with or without content and of bones and bone products containing vertebral column and skull, subject to compliance with the following requirements:</i><br><br>Annex XIV, Chapter IV, Section 1:<br><b>Imports of certain Category 1 materials</b><br><i>Materials referred to in Article 26 shall be imported under the following conditions:</i><br><ol style="list-style-type: none"> <li>1. <i>The materials shall be imported with a label attached to the packaging, container or vehicle which indicates 'Prohibited in food, feed, fertilisers, cosmetics, medicinal products and medical devices'.</i></li> <li>2. <i>The materials shall be directly delivered to an approved or registered establishment or plant for the manufacture of derived products, other than the products referred to in point 1.</i></li> <li>3. <i>Unused or surplus materials shall be used or disposed of in accordance with Article 12 of Regulation (EC) No 1069/2009.</i></li> </ol> |
| <b>Organic</b>   |  |  |
| <b>Reference + link</b>  | <b>Subject</b>   | <b>Specific text on casings, keywords or comment</b>   |
| <a href="#">Council Regulation (EC) No 834/2007</a><br>(consleg)             | on organic production and labelling of organic products and repealing Regulation (EEC) No 2092/91  |  |
| <a href="#">Commission Regulation (EC) No 889/2008</a><br>(consleg) →Amended | laying down detailed rules for the implementation of Council Regulation (EC) No 834/2007 on organic production and labelling of organic products with regard to organic production, labelling and control  | ANNEX IX:<br><b>Ingredients of agricultural origin which have not been produced organically referred to in Article 28</b><br><br>3. ANIMAL PRODUCTS<br>- Casings   |
| <b>Further legal requirements</b>  |  |  |
| <b>Reference + link</b>  | <b>Subject</b>   |  |
| <a href="#">Commission Decision 2004/292/EC</a><br>(consleg)                 | on the introduction of the TRACES system and Decision 92/486/EEC   |  |
| <a href="#">Commission Regulation (EC) No 1549/2006</a>                      | amending Annex I to Council Regulation (EEC) No 2658/87 on the tariff and statistical nomenclature and on the Common Customs Tariff  |  |



c/o UECBV

Rue de la Loi 81A Bte 9

1040 BRUSSELS

BELGIUM

Email: [info@ensca.eu](mailto:info@ensca.eu)

Website: <http://www.ensca.eu>